



TL-395

Test Report issued under the responsibility of:



TEST REPORT IEC 62109-1 Safety of Power Converter for use in Photovoltaic Power Systems Part 1: General requirements	
Report Number :	210623182GZU-001
Date of issue :	27 Jul 2021
Total number of pages	80 pages
Name of Testing Laboratory preparing the Report	Intertek Testing Services Shenzhen Ltd. Guangzhou Branch Room 02, & 101/E201/E301/E401/E501/E601/E701/E801 of Room 01 1-8/F., No. 7-2. Caipin Road, Science City, GETDD, Guangzhou, Guangdong, China
Applicant's name	INVT Solar Technology (Shenzhen) Co., Ltd.
Address :	6 th Floor, Block A, INVT Guangming Technology Building, Kejie Fourth Road, Shutianpu Community, Matian Guangming District, 518000 Shenzhen, PEOPLE'S REPUBLIC OF CHINA
Test specification:	
Standard	IEC/EN 62109-1:2010 (First Edition)
Test procedure	Type approval
Non-standard test method	N/A
Test Report Form No.	IEC62109_1B
Test Report Form(s) Originator :	VDE Testing and Certification Institute
Master TRF	Dated 2016-04
Copyright © 2016 IEC System of Conformity Assessment Schemes for Electrotechnical Equipment and Components (IECEE System). All rights reserved. This publication may be reproduced in whole or in part for non-commercial purposes as long as the IECEE is acknowledged as copyright owner and source of the material. IECEE takes no responsibility for and will not assume liability for damages resulting from the reader's interpretation of the reproduced material due to its placement and context. If this Test Report Form is used by non-IECEE members, the IECEE/IEC logo and the reference to the CB Scheme procedure shall be removed. This report is not valid as a CB Test Report unless signed by an approved CB Testing Laboratory and appended to a CB Test Certificate issued by an NCB in accordance with IECEE 02.	
General disclaimer:	
The test results presented in this report relate only to the object tested. This report shall not be reproduced, except in full, without the written approval of the Issuing CB Testing Laboratory. The authenticity of this Test Report and its contents can be verified by contacting the NCB, responsible for this Test Report.	

Test item description :	Grid-tied Solar inverter		
Trade Mark :	invt		
Manufacturer	Same as applicant		
Model/Type reference :	iMars XG100KTR, iMars XG100KTR-F, iMars XG110KTR, iMars XG110KTR-F, iMars XG136KTR-L, iMars XG136KTR-LF, iMars XG136KTR-X, iMars XG136KTR-XF		
Ratings :	Model	iMars XG100KTR	iMars XG100KTR-F
	Max.PV voltage	1100Vdc	
	MPPT voltage range	180V – 1000Vdc	
	Max.input current	26A*9	30A*9
	PV Isc	40A*9	
	Nominal output voltage	3/N/PE, 230/400Vac	
	Nominal output Frequency	50/60Hz	
	Max.output current	158.8A	
	Rated output power	100KW	
	Max.apparent power	110KVA	
	Power factor range	0.8Leading – 0.8 lagging	
	Safety level	Class I	
	Ingress Protection	IP 66	
	Operation Ambient Temperature	-30°C - +60°C	
	Software version	V1.1	
	Model	iMars XG110KTR	iMars XG110KTR-F
	Max.PV voltage	1100Vdc	
	MPPT voltage range	180V – 1000Vdc	
	Max.input current	26A*10	30A*10
	PV Isc	40A*10	
	Nominal output voltage	3/N/PE, 230/400Vac	
	Nominal output Frequency	50/60Hz	
	Max.output current	174.6A	
	Rated output power	110KW	
	Max.apparent power	121KVA	

Power factor range	0.8Leading – 0.8 lagging	
Safety level	Class I	
Ingress Protection	IP 66	
Operation Ambient Temperature	-30°C - +60°C	
Software version	V1.1	
Model	iMars XG136KTR-L	iMars XG136KTR-LF
Max.PV voltage	1100Vdc	
MPPT voltage range	180V – 1000Vdc	
Max.input current	26A*12	30A*12
PV Isc	40A*12	
Nominal output voltage	3/N/PE, 277/480Vac	
Nominal output Frequency	50/60Hz	
Max.output current	174.6A	
Rated output power	136KW	
Max.apparent power	150KVA	
Power factor range	0.8Leading – 0.8 lagging	
Safety level	Class I	
Ingress Protection	IP 66	
Operation Ambient Temperature	-30°C - +60°C	
Software version	V1.1	
Model	iMars XG136KTR-X	iMars XG136KTR-XF
Max.PV voltage	1100Vdc	
MPPT voltage range	180V – 1000Vdc	
Max.input current	26A*12	30A*12
PV Isc	40A*12	
Nominal output voltage	3/N/PE, 311/540Vac	
Nominal output Frequency	50/60Hz	
Max.output current	160.4A	
Rated output power	136KW	
Max.apparent power	150KVA	









	Power factor range	0.8Leading – 0.8 lagging
	Safety level	Class I
	Ingress Protection	IP 66
	Operation Ambient Temperature	-30°C - +60°C
	Software version	V1.1









Responsible Testing Laboratory (as applicable), testing procedure and testing location(s):		
<input checked="" type="checkbox"/>	Testing Laboratory:	Intertek Testing Services Shenzhen Ltd. Guangzhou Branch
Testing location/ address		Room 02, & 101/E201/E301/E401/E501/E601/E701/E801 of Room 01 1-8/F., No. 7-2. Caipin Road, Science City, GETDD, Guangzhou, Guangdong, China
<input type="checkbox"/>	Associated CB Testing Laboratory:	N/A
Testing location/ address		N/A
Tested by (name, function, signature).....:		Gaison Li Engineer <i>Gaison Li</i>
Approved by (name, function, signature)....:		Jason Fu Supervisor <i>Jason Fu</i>
<input type="checkbox"/>	Testing procedure: CTF Stage 1:	N/A
Testing location/ address		N/A
Tested by (name, function, signature).....:		N/A
Approved by (name, function, signature)....:		N/A
<input type="checkbox"/>	Testing procedure: CTF Stage 2:	N/A
Testing location/ address		N/A
Tested by (name + signature)		N/A
Witnessed by (name, function, signature) .:		N/A
Approved by (name, function, signature)....:		N/A
<input type="checkbox"/>	Testing procedure: CTF Stage 3:	N/A
<input type="checkbox"/>	Testing procedure: CTF Stage 4:	N/A
Testing location/ address		N/A
Tested by (name, function, signature).....:		N/A
Witnessed by (name, function, signature) .:		N/A
Approved by (name, function, signature)....:		N/A
Supervised by (name, function, signature) :		N/A

List of Attachments (including a total number of pages in each attachment): N/A	
Summary of testing:	
Tests performed (name of test and test clause): All applicable tests	Testing location: Intertek Testing Services Shenzhen Ltd. Guangzhou Branch Room 02, & 101/E201/E301/E401/E501/E601/E701/E801 of Room 01 1-8/F., No. 7-2. Caipin Road, Science City, GETDD, Guangzhou, Guangdong, China
Summary of compliance with National Differences (List of countries addressed): N/A	
<input checked="" type="checkbox"/> The product fulfils the requirements of IEC/EN 62109-1:2010 (First Edition)	

Copy of marking plate:

The artwork below may be only a draft. The use of certification marks on a product must be authorized by the respective NCBS that own these marks.

 Grid-tied Solar Inverter iMars XG136KTR-L		 Grid-tied Solar Inverter iMars XG136KTR-LF		 Grid-tied Solar Inverter iMars XG136KTR-X		 Grid-tied Solar Inverter iMars XG136KTR-XF	
DC Input		DC Input		DC Input		DC Input	
Vmax. PV	1100V	Vmax. PV	1100V	Vmax. PV	1100V	Vmax. PV	1100V
MPPT Range	180V-1000V	MPPT Range	180V-1000V	MPPT Range	180V-1000V	MPPT Range	180V-1000V
Max. Current	26AX12	Max. Current	30AX12	Max. Current	26AX12	Max. Current	30AX12
Isc PV	40AX12	Isc PV	40AX12	Isc PV	40AX12	Isc PV	40AX12
AC Output		AC Output		AC Output		AC Output	
Nominal Voltage	3/N/PE,277/480V	Nominal Voltage	3/N/PE,277/480V	Nominal Voltage	3/N/PE,311/540V	Nominal Voltage	3/N/PE,311/540V
Nominal Current	174.6A	Nominal Current	174.6A	Nominal Current	160.4A	Nominal Current	160.4A
Rated Power	136000W	Rated Power	136000W	Rated Power	136000W	Rated Power	136000W
Max. Apparent Power	150000VA	Max. Apparent Power	150000VA	Max. Apparent Power	150000VA	Max. Apparent Power	150000VA
Frequency	50Hz/60Hz	Frequency	50Hz/60Hz	Frequency	50Hz/60Hz	Frequency	50Hz/60Hz
Power factor range	0.80un ~ 0.80ov	Power factor range	0.80un ~ 0.80ov	Power factor range	0.80un ~ 0.80ov	Power factor range	0.80un ~ 0.80ov
Environment		Environment		Environment		Environment	
Temperature	-30°C ~ +60°C	Temperature	-30°C ~ +60°C	Temperature	-30°C ~ +60°C	Temperature	-30°C ~ +60°C
Protective Class	I	Protective Class	I	Protective Class	I	Protective Class	I
Inverter topology	Non-isolated	Inverter topology	Non-isolated	Inverter topology	Non-isolated	Inverter topology	Non-isolated
Ingress protection	IP66	Ingress protection	IP66	Ingress protection	IP66	Ingress protection	IP66
							
Made in China		Made in China		Made in China		Made in China	
INVT Solar Technology (Shenzhen) Co., Ltd.		INVT Solar Technology (Shenzhen) Co., Ltd.		INVT Solar Technology (Shenzhen) Co., Ltd.		INVT Solar Technology (Shenzhen) Co., Ltd.	

 Grid-tied Solar Inverter iMars XG100KTR		 Grid-tied Solar Inverter iMars XG100KTR-F		 Grid-tied Solar Inverter iMars XG110KTR		 Grid-tied Solar Inverter iMars XG110KTR-F	
DC Input		DC Input		DC Input		DC Input	
Vmax. PV	1100V	Vmax. PV	1100V	Vmax. PV	1100V	Vmax. PV	1100V
MPPT Range	180V-1000V	MPPT Range	180V-1000V	MPPT Range	180V-1000V	MPPT Range	180V-1000V
Max. Current	26AX9	Max. Current	30AX9	Max. Current	26AX10	Max. Current	30AX10
Isc PV	40AX9	Isc PV	40AX9	Isc PV	40AX10	Isc PV	40AX10
AC Output		AC Output		AC Output		AC Output	
Nominal Voltage	3/N/PE,230/400V	Nominal Voltage	3/N/PE,230/400V	Nominal Voltage	3/N/PE,230/400V	Nominal Voltage	3/N/PE,230/400V
Nominal Current	158.8A	Nominal Current	158.8A	Nominal Current	174.6A	Nominal Current	174.6A
Rated Power	100000W	Rated Power	100000W	Rated Power	110000W	Rated Power	110000W
Max. Apparent Power	110000VA	Max. Apparent Power	110000VA	Max. Apparent Power	121000VA	Max. Apparent Power	121000VA
Frequency	50Hz/60Hz	Frequency	50Hz/60Hz	Frequency	50Hz/60Hz	Frequency	50Hz/60Hz
Power factor range	0.80un ~ 0.80ov	Power factor range	0.80un ~ 0.80ov	Power factor range	0.80un ~ 0.80ov	Power factor range	0.80un ~ 0.80ov
Environment		Environment		Environment		Environment	
Temperature	-30°C ~ +60°C	Temperature	-30°C ~ +60°C	Temperature	-30°C ~ +60°C	Temperature	-30°C ~ +60°C
Protective Class	I	Protective Class	I	Protective Class	I	Protective Class	I
Inverter topology	Non-isolated	Inverter topology	Non-isolated	Inverter topology	Non-isolated	Inverter topology	Non-isolated
Ingress protection	IP66	Ingress protection	IP66	Ingress protection	IP66	Ingress protection	IP66
							
Made in China		Made in China		Made in China		Made in China	
INVT Solar Technology (Shenzhen) Co., Ltd.		INVT Solar Technology (Shenzhen) Co., Ltd.		INVT Solar Technology (Shenzhen) Co., Ltd.		INVT Solar Technology (Shenzhen) Co., Ltd.	

Note:

1. The above markings are the minimum requirements required by the safety standard. For the final production samples, the additional markings which do not give rise to misunderstanding may be added.
2. Label is attached on the side surface of enclosure and visible after installation.
3. Other labels are identical to above, except the model name and ratings

Test item particulars :			
Equipment mobility :	<input type="checkbox"/> movable	<input type="checkbox"/> hand-held	<input type="checkbox"/> stationary
	<input checked="" type="checkbox"/> fixed	<input type="checkbox"/> transportable	<input type="checkbox"/> for building-in
Connection to the mains :	<input type="checkbox"/> pluggable equipment	<input type="checkbox"/> direct plug-in	
	<input checked="" type="checkbox"/> permanent connection	<input type="checkbox"/> for building-in	
Environmental category :	<input checked="" type="checkbox"/> outdoor	<input type="checkbox"/> indoor unconditional	<input type="checkbox"/> indoor conditional
Over voltage category Mains :	<input type="checkbox"/> OVC I	<input type="checkbox"/> OVC II	<input checked="" type="checkbox"/> OVC III
	<input type="checkbox"/> OVC IV		
Over voltage category DC :	<input type="checkbox"/> OVC I	<input checked="" type="checkbox"/> OVC II	<input type="checkbox"/> OVC III
		<input type="checkbox"/> OVC IV	
Mains supply tolerance (%)	-90 / +110 %		
Tested for power systems	TN systems		
IT testing, phase-phase voltage (V) :	- - -		
Class of equipment :	<input checked="" type="checkbox"/> Class I	<input type="checkbox"/> Class II	<input type="checkbox"/> Class III
	<input type="checkbox"/> Not classified		
Mass of equipment (kg) :	Approx. 126Kg		
Pollution degree	Outside PD3; Inside PD2		
IP protection class	IP 66		
..... :			
Possible test case verdicts:			
- test case does not apply to the test object : N/A			
- test object does meet the requirement..... : P (Pass)			
- test object was not evaluated for the requirement..... : N/E			
- test object does not meet the requirement : F (Fail)			
Testing			
Date of receipt of test item : 23 Jun 2021			
Date (s) of performance of tests			
: 24 Jun 2021 to 26 Jul 2021			

General remarks:	
<p>"(See Enclosure #)" refers to additional information appended to the report. "(See appended table)" refers to a table appended to the report.</p> <p>Throughout this report a <input type="checkbox"/> comma / <input checked="" type="checkbox"/> point is used as the decimal separator.</p> <p>This report shall be used together with report No.210623182GZU-002</p>	
Manufacturer's Declaration per sub-clause 4.2.5 of IEC60068-2-21:	
The application for obtaining a CB Test Certificate includes more than one factory location and a declaration from the Manufacturer stating that the sample(s) submitted for evaluation is (are) representative of the products from each factory has been provided..... :	<input type="checkbox"/> Yes <input checked="" type="checkbox"/> Not applicable
When differences exist; they shall be identified in the General product information section.	
Name and address of factory (ies) : Shenzhen INVT Electric Co., Ltd. (Baoan Factory) 4 th to 1 st floors of Emerson Industrial Park, No. 3, Fengtang Avenue, Tangwei Community, Fuhai Street, Baoan District, Shenzhen, CHINA.	

General product information:

The control system is divided into DC and AC control. AC-DSP and CPLD on the AC side mainly monitors the voltage, current, frequency and GFCI on the grid side, and participates in the inverter control.

The DC-DSP monitors the voltage, current, and ISO on the PV input side, and participates in the BOOS booster circuit and maximum power MPPT point tracking.

There is an internal communication circuit between the two DSP to coordinate with each other to complete the software function of the whole machine.

The ARM monitoring board does not participate in the control of the whole system. It communicates with the DC-SPS to collect the data of the whole system.

The relays (K3,K4,K5,K6) are designed on redundant structure where K4,K6 are controlled by DC-DSP and K5,K6 are controlled by AC-DSP.

The AC-DSP and DC-DSP are used together to control relay open or close, if the single fault on one controller, the other controller can be capable of opening the relay, so that still providing safety means.

The topology diagram as following:

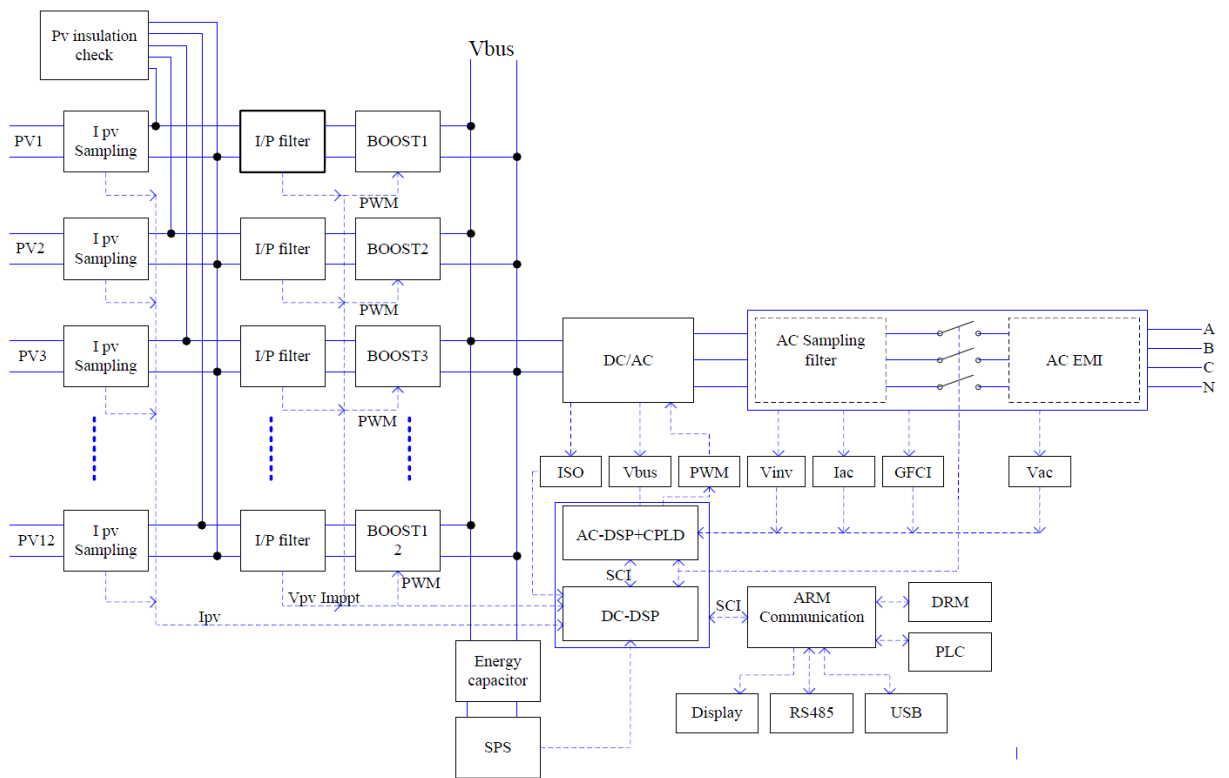

Model differences:

All models are identical, except the output power derating in software and components as list in CDF.

The detailed difference as following:

Model	iMars XG100KTR, iMars XG100KTR-F	iMars XG110KTR, iMars XG110KTR-F	iMars XG136KTR-L, iMars XG136KTR-LF	iMars XG136KTR-X, iMars XG136KTR-XF
PV input	9 strings MPPT Each MPPT: two string input	10 strings MPPT Each MPPT: two string input	12 strings MPPT Each MPPT: two string input	
AC output voltage	230/400Vac		277/480Vac	311/540Vac

The product was tested on:



The Software version: V1.1

The Hardware version: VA.1

Other than special notes, typical model iMars XG136KTR-L used as representative for testing in this report.

IEC 62109-1			
Clause	Requirement – Test	Result – Remark	Verdict
4	GENERAL TESTING REQUIREMENTS		P
4.1	General		P
4.2	General conditions for testing		P
4.2.1	Sequence of tests		P
4.2.2	Reference test conditions		P
4.2.2.1	Environmental conditions	Max. 60°C rated ambient temperature tested.	P
4.2.2.2	State of equipment		P
4.2.2.3	Position of equipment	Be fixed in accordance with the manufacturer's instruction	P
4.2.2.4	Accessories		P
4.2.2.5	Covers and removable parts		N/A
4.2.2.6	Mains supply a) Voltage: b) Frequency: c) Polarity: d) Earthing: e) Over-current Protection:	(see appended table 4.2.2.6)	P
4.2.2.7	Supply ports other than the mains		P
4.2.2.7.1	Photovoltaic supply sources a) Open circuit voltage: b) Short-circuit current:	(see appended table 4.2.2.7)	P
4.2.2.7.2	Battery inputs		N/A
4.2.2.8	Conditions of loading for output ports		P
4.2.2.9	Earthing terminals		P
4.2.2.10	Controls		N/A
4.2.2.11	Available short circuit current		P
4.3	Thermal testing	(see appended table 4.3)	P
4.3.1	General		P
4.3.2	Maximum temperatures		P
4.3.2.1	General		P
4.3.2.2	Touch temperatures		P
4.3.2.3	Temperature limits for mounting surfaces		P
4.4	Testing in single fault condition	(see appended table 4.4)	P
4.4.1	General		P
4.4.2	Test conditions and duration for testing under fault conditions		P

IEC 62109-1			
Clause	Requirement – Test	Result – Remark	Verdict
4.4.2.1	General		P
4.4.2.2	Duration of tests		P
4.4.3	Pass/fail criteria for testing under fault conditions		P
4.4.3.1	Protection against shock hazard		P
4.4.3.2	Protection against the spread of fire		P
4.4.3.3	Protection against other hazards		P
4.4.3.4	Protection against parts expulsion hazards		P
4.4.4	Single fault conditions to be applied	(See appended tables)	P
4.4.4.1	Component fault tests		P
4.4.4.2	Equipment or parts for short-term or intermittent operation	Not for short-term or intermittent operation	N/A
4.4.4.3	Motors		P
4.4.4.4	Transformer short circuit tests		P
4.4.4.5	Output short circuit		P
4.4.4.6	Backfeed current test for equipment with more than one source of supply	Considered	P
4.4.4.7	Output overload		P
4.4.4.8	Cooling system failure	Blanketing test for the heatsink according to IEC 62109-2 Clause 4.4.4.17	P
4.4.4.9	Heating devices	No heating devices	N/A
4.4.4.10	Safety interlock systems	No safety interlock	N/A
4.4.4.11	Reverse d.c. connections	Reverse DC+ and DC-, the PCE cannot start-up. No damaged.	P
4.4.4.12	Voltage selector mismatch	No voltage selector	N/A
4.4.4.13	Mis-wiring with incorrect phase sequence or polarity		P
4.4.4.14	Printed wiring board short-circuit test		P
4.5	Humidity preconditioning	(see appended table 7.5)	P
4.5.1	General		P
4.5.2	Conditions	95% R.H. 40°C. 48H	P
4.6	Backfeed voltage protection		P
4.6.1	Backfeed tests under normal conditions	The max. DC input and output are less than 60V, disconnected DC inputs and main	P
4.6.2	Backfeed tests under single-fault conditions	PV input is separated from Main in accordance with 62109-2s under normal and single-fault conditions with	P

IEC 62109-1			
Clause	Requirement – Test	Result – Remark	Verdict
		disconnection method evaluated to IEC 62109-2 Also,    is presented on the marking label means that “After disconnect must wait for 5 mins can touch with PCE terminal”	
4.6.3	Compliance with backfeed tests		P
4.7	Electrical ratings tests	(see appended table 4.2.2.6)	P
4.7.1	Input ratings		P
4.7.1.1	Measurement requirements for DC input ports		P
4.7.2	Output ratings		P

5	MARKING AND DOCUMENTATION		P
5.1	Marking		P
5.1.1	General		P
	Equipment shall bear markings as specified in 5.1 and 5.2	Label are marked on PCE and graphic symbol is explained in user manual	P
	Graphic symbols may be used and shall be in accordance with Annex C or IEC 60417 as applicable.		P
	Graphic symbols shall be explained in the documentation provided with the PCE.		P
5.1.2	Durability of markings		P
	Markings required by this clause to be located on the PCE shall remain clear and legible under conditions of NORMAL USE and resist the effects of cleaning agents specified by the manufacturer	After this test, the markings are clearly legible. There was neither loose nor curling on the edge of label.	P
5.1.3	Identification		P
	The equipment shall, as a minimum, be permanently marked with:		P
	a) the name or trade mark of the manufacturer or supplier	Trade mark: invt	P
	b) model number, name or other means to identify the equipment		P
	c) a serial number, code or other marking allowing identification of manufacturing location and the manufacturing batch or date within a three month time period.	Within three months	P
5.1.4	Equipment ratings	See below	P

IEC 62109-1			
Clause	Requirement – Test	Result – Remark	Verdict
	Unless otherwise specified in another part of IEC 62109, the following ratings, as applicable shall be marked on the equipment:		P
	– input voltage, type of voltage (a.c. or d.c.), frequency, and max. continuous current for each input	Refer to the marking label	P
	– output voltage, type of voltage (a.c. or d.c.), frequency, max. continuous current, and for a.c. outputs, either the power or power factor for each output	Refer to the marking label	P
	– the ingress protection (IP) rating as in 6.3 below	IP 66	P
5.1.5	Fuse identification		N/A
	Marking shall be located adjacent to each fuse or fuseholder, or on the fuseholder, or in another location provided that it is obvious to which fuse the marking applies, giving the fuse current rating and where fuses of different voltage rating value could be fitted, the fuse voltage rating.		N/A
	Where fuses with special fusing characteristics such as time delay or breaking capacity are necessary, the type shall also be indicated		N/A
	For fuses not located in operator access areas and for soldered-in fuses located in operator access areas, it is permitted to provide an unambiguous cross-reference (for example, F1, F2, etc.) to the servicing instructions which shall contain the relevant information.		N/A
5.1.6	Terminals, Connections, and Controls		P
	If necessary for safety, an indication shall be given of the purpose of Terminals, connectors, controls, and indicators, and their various positions, including any connections for coolant fluids such as water and drainage. The symbols in Annex C may be used, and where there is insufficient space, symbol 9 of Annex C may be used.	The indications were provided adjacent to PV connectors and AC terminal	P
	Push-buttons and actuators of emergency stop devices, and indicator lamps used only to indicate a warning of danger or the need for urgent action shall be coloured red.		P
	A multiple-voltage unit shall be marked to indicate the particular voltage for which it is set when shipped from the factory. The marking is allowed to be in the form of a paper tag or any other non-permanent material.	The PCE is not intended to connect to multiple-voltage and there is no voltage setting device.	N/A
	A unit with d.c. terminals shall be plainly marked indicating the polarity of the connections, with:	The “+” and “-” marking were provided adjacent to the PV input terminals	P
	– the sign “+” for positive and “-”, for negative; or		P

IEC 62109-1			
Clause	Requirement – Test	Result – Remark	Verdict
	– a pictorial representation illustrating the proper polarity where the correct polarity can be unambiguously determined from the representation	Not provided	N/A
5.1.6.1	Protective Conductor Terminals		P
	The means of connection for the protective earthing conductor shall be marked with:		P
	– symbol 7 of Annex C; or		P
	– the letters “PE”; or		N/A
	– the colour coding green-yellow.		P
5.1.7	Switches and circuit-breakers	Approved switch was used for all models.	P
	The on and off-positions of switches and circuits breakers shall be clearly marked. If a push-button switch is used as the power switch, symbols 10 and 16 of Annex C may be used to indicate the on-position, or symbols 11 and 17 to indicate the off-position, with the pair of symbols (10 and 16, or 11 and 17) close together.	“ON” indicated the on-position of DC switch. “OFF” indicated the off-position of DC switch	P
5.1.8	Class II Equipment	Class I	N/A
	Equipment using Class II protective means throughout shall be marked with symbol 12 of Annex C. Equipment which is only partially protected by DOUBLE INSULATION or REINFORCED INSULATION shall not bear symbol 12 of Table Annex C.		N/A
	Where such equipment has provision for the connection of an earthing conductor for functional reasons (see 7.3.6.4) it shall be marked with symbol 6 of Annex C		N/A
5.1.9	Terminal boxes for External Connections	No such parts	N/A
	Where required by note 1 of Table 2 as a result of high temperatures of terminals or parts in the wiring compartment, there shall be a marking, visible beside the terminal before connection, of either:		N/A
	a) the minimum temperature Rating and size of the cable to be connected to the TERMINALS; or		N/A
	b) a marking to warn the installer to consult the installation instruction. Symbol 9 of Table D-1 is an acceptable marking		N/A
5.2	Warning markings		P
5.2.1	Visibility and legibility requirements for warning markings		P
	Warning markings shall be legible, and shall have		P

IEC 62109-1			
Clause	Requirement – Test	Result – Remark	Verdict
	minimum dimensions as follows:		
	– Printed symbols shall be at least 2,75 mm high		P
	– Printed text characters shall be at least 1.5 mm high and shall contrast in colour with the background		P
	– Symbols or text that are moulded, stamped or engraved in a material shall have a character height of at least 2,0 mm, and if not contrasting in colour from the background, shall have a depth or raised height of at least 0,5 mm.		P
	If it is necessary to refer to the instruction manual to preserve the protection afforded by the equipment, the equipment shall be marked with symbol 9 of Annex C	The manual provides necessary information for warning marking	P
	Symbol 9 of Annex C is not required to be used adjacent to symbols that are explained in the manual		P
5.2.2	Content for warning markings		P
5.2.2.1	Ungrounded heat sinks and similar parts	Grounded heatsink	N/A
	An ungrounded heat sink or other part that may be mistaken for a grounded part and involves a risk of electric shock in accordance with 7.3 shall be marked with symbol 13 of Annex C, or equivalent. The marking may be on or adjacent to the heat sink and shall be clearly visible when the PCE is disassembled to the extent that a risk of contact with the heat sink exists.		N/A
5.2.2.2	Hot Surfaces		P
	A part of the PCE that exceeds the temperature limits specified in 4.3.2 shall be marked with symbol 14 of Annex C or equivalent.	The symbol 14 of Annex C provided on the warning label which located on the surface of enclosure	P
5.2.2.3	Coolant	Coolant is not used	N/A
	A unit containing coolant that exceeds 70 °C shall be legibly marked externally where readily visible after installation with symbol 15 of Annex C. The documentation shall provide a warning regarding the risk of burns from hot coolant, and either:		N/A
	a) statement that coolant system servicing is to be done only by SERVICE PERSONNEL, or		N/A
	b) instructions for safe venting, draining, or otherwise working on the cooling system, if these operations can be performed without OPERATOR access to HAZARDS internal to the equipment		N/A
5.2.2.4	Stored energy		P

IEC 62109-1			
Clause	Requirement – Test	Result – Remark	Verdict
	Where required by 7.3.9.2 or 7.4.2 the PCE shall be marked with Symbol 21 of Annex C and the time to discharge capacitors to safe voltage and energy levels shall accompany the symbol.		P
5.2.2.5	Motor guarding		N/A
	Where required by 8.2 a marking shall be provided where it is visible to service personnel before removal of a guard, warning of the hazard and giving instructions for safe servicing (for example disconnection of the source before removing the guard).		N/A
5.2.3	Sonic hazard markings and instructions	Hazardous noise is not produced	N/A
	If required by 10.2.1 a PCE shall:		N/A
	a) be marked to warn the operator of the sonic pressure hazard; or		N/A
	b) be provided with installation instructions that specify how the installer can ensure that the sound pressure level from equipment at its point of use after installation, will not reach a value, which could cause a hazard. These instructions shall include the measured sound pressure level, and shall identify readily available and practicable protective materials or measures which may be used.		N/A
5.2.4	Equipment with multiple sources of supply		P
	A PCE with connections for multiple energy sources shall be marked with symbol 13 of Annex C and the manual shall contain the information required in 5.3.4.	Marked with symbol 13 of Annex C and explained in User manual.	P
	The symbol shall be located on the outside of the unit or shall be prominently visible behind any cover giving access to hazardous parts.		P
5.2.5	Excessive touch current		P
	Where required by 7.3.6.3.7 the PCE shall be marked with symbol 15 of Annex C. See also 5.3.2 for information to be provided in the installation manual.	It is provided a second protective earthing conductor, in addition, the caution symbol 15 of Annex C is fixed to the product and provided details of protective earthing in installation	P
5.3	Documentation		P
5.3.1	General		P
	The documentation provided with the PCE shall provide the information needed for the safe operation, installation, and (where applicable) maintenance of the equipment. The documentation		P

IEC 62109-1			
Clause	Requirement – Test	Result – Remark	Verdict
	shall include the items required in 5.3.2 through 5.3.4, and the following:		
	a) explanations of equipment makings, including symbols used		P
	b) location and function of terminals and controls		P
	c) all ratings or specifications that are necessary to safely install and operate the PCE, including the following environmental ratings along with an explanation of their meaning and any resulting installation requirements:		P
	– ENVIRONMENTAL CATEGORY as per 6.1	Outdoor	P
	– WET LOCATIONS classification for the intended external environment as per 6.1	Suitable for wet location	P
	– POLLUTION DEGREE classification for the intended external environment as per 6.2	Outside: PD3, Inside: PD2	P
	– INGRESS PROTECTION rating as per 6.3	IP 66	P
	– Ambient temperature and relative humidity ratings	Max. +60°C and 100% R.H.	P
	– MAXIMUM altitude rating	4000m	P
	– OVERVOLTAGE CATEGORY assigned to each input and output port as per 7.3.7.1.2, accompanied by guidance regarding how to ensure that the installation complies with the required overvoltage categories;	OVC II(PV), OVC III(Mains)	P
	d) a warning that when the photovoltaic array is exposed to light, it supplies a d.c. voltage to the PCE		P
5.3.1.1	Language	English provide	P
	Instructions related to safety shall be in a language that is acceptable in the country where the equipment is to be installed.	For other country language further evaluated is needed	N/A
5.3.1.2	Format		P
	In general, the documentation must be provided in printed form and is to be delivered with the equipment.	Printed form provided	P
	For equipment which requires the use of a computer for both installation and operation, documentation may be provided in electronic format without accompanying printed format.		N/A
5.3.2	Information related to installation		P
	The documentation shall include installation and where applicable, specific commissioning instructions and, if necessary for safety, warnings against hazards which could arise during		P

IEC 62109-1			
Clause	Requirement – Test	Result – Remark	Verdict
	installation or commissioning of the equipment. The information provided shall include:		
	a) assembly, location, and mounting requirements;		P
	b) ratings and means of connection to each source of supply and any requirements related to wiring and external controls, colour coding of leads, disconnection means, or overcurrent protection needed, including instructions that the installation position shall not prevent access to the disconnection means;		P
	c) ratings and means of connection of any outputs from the PCE, and any requirements related to wiring and external controls, colour coding of leads, or overcurrent protection needed;		P
	d) explanation of the pin-out of connectors for external connections, unless the connector is used for a standard purpose (e.g. RS 232)		P
	e) ventilation requirements;		P
	f) requirements for special services, for example cooling liquid;		N/A
	g) instructions and information relating to sound pressure level if required by 10.2.1;		N/A
	h) where required by 14.8.1.3, instructions for the adequate ventilation of the room or location in which PCE containing vented or valve-regulated batteries is located, to prevent the accumulation of hazardous gases;		N/A
	i) tightening torque to be applied to wiring terminals;		N/A
	j) values of backfeed short-circuit currents available from the PCE on input and output conductors under fault conditions, if those currents exceed the max. rated current of the circuit, as per 4.4.4.6;	The backfeed current was prevented.	N/A
	k) for each input to the PCE, the max value of short-circuit current available from the source, for which the PCE is designed; and		P
	l) compatibility with RCD and RCM;	Internal RCM is used	N/A
	m) instructions for protective earthing, including the information required by 7.3.6.3.7 if a second protective earthing conductor is to be installed:		P
	n) where required by 7.3.8, the installation instructions shall include the following or equivalent wording:		N/A
	“This product can cause a d.c. current in the external protective earthing conductor. Where a	Internal RCM is used	N/A

IEC 62109-1			
Clause	Requirement – Test	Result – Remark	Verdict
	residual current-operated protective (RCD) or monitoring (RCM) device is used for protection in a case of direct or indirect contact, only an RCD or RCM of Type B is allowed on the supply side of this product.“		
	o) for PCE intended to charge batteries, the battery nominal voltage rating, size, and type		N/A
	p) PV array configuration information, such as ratings, whether the array is to be grounded or floating, any external protection devices needed, etc.	PV array should be floating configuration to be connected to PCE, relevant information had shown on the installation manual.	P
5.3.3	Information related to operation		P
	Instructions for use shall include any operating instructions necessary to ensure safe operation, including the following, as applicable:		P
	– Instructions for adjustment of controls including the effects of adjustment;		P
	– Instructions for interconnection to accessories and other equipment, including indication of suitable accessories, detachable parts and any special materials;		P
	– Warnings regarding the risk of burns from surfaces permitted to exceed the temperature limits of 4.3.2 and required operator actions to reduce the risk; and		P
	– Instructions, that if the equipment is used in a manner not specified by the manufacturer, the protection provided by the equipment may be impaired.		P
5.3.4	Information related to maintenance		P
	Maintenance instructions shall include the following:		P
	– Intervals and instructions for any preventive maintenance that is required to maintain safety (for example air filter replacement or periodic re-tightening of terminals);		P
	– Instructions for accessing operator access areas, if any are present, including a warning not to enter other areas of the equipment;	No such part	P
	– Part numbers and instructions for obtaining any required operator replaceable parts;		N/A
	– Instructions for safe cleaning (if recommended)		N/A
	– Where there is more than one source of supply energizing the PCE, information shall be provided in the manual to indicate which disconnect device or devices are required to be		P

IEC 62109-1			
Clause	Requirement – Test	Result – Remark	Verdict
	operated in order to completely isolate the equipment.		
5.3.4.1	Battery maintenance	No such parts	N/A
	Where required by 14.8.5, the documentation shall include the applicable items from the following list of instructions regarding maintenance of batteries:		N/A
	– Servicing of batteries should be performed or supervised by personnel knowledgeable about batteries and the required precautions		N/A
	– When replacing batteries, replace with the same type and number of batteries or battery packs		N/A
	– General instructions regarding removal and installation of batteries		N/A
	– CAUTION: Do not dispose of batteries in a fire. The batteries may explode.		N/A
	– CAUTION: Do not open or damage batteries. Released electrolyte is harmful to the skin and eyes. It may be toxic.		N/A
	– CAUTION: A battery can present a risk of electrical shock and high short-circuit current. The following precautions should be observed when working on batteries:		N/A
	a) Remove watches, rings, or other metal objects.		N/A
	b) Use tools with insulated handles.		N/A
	c) Wear rubber gloves and boots.		N/A
	d) Do not lay tools or metal parts on top of batteries		N/A
	e) Disconnect charging source prior to connecting or disconnecting battery terminals		N/A
	f) Determine if battery is inadvertently grounded. If inadvertently grounded, remove source from ground. Contact with any part of a grounded battery can result in electrical shock. The likelihood of such shock can be reduced if such grounds are removed during installation and maintenance (applicable to equipment and remote battery supplies not having a grounded supply circuit).		N/A
6	ENVIRONMENTAL REQUIREMENTS AND CONDITIONS		P
	The manufacturer shall rate the PCE for the following environmental conditions:		P
	– ENVIRONMENTAL CATEGORY, as in 6.1 below	Outdoor used	P

IEC 62109-1			
Clause	Requirement – Test	Result – Remark	Verdict
	– Suitability for WET LOCATIONS or not	Yes	P
	– POLLUTION DEGREE rating in 6.2 below	Outside PD3, Inside PD2	P
	– INGRESS PROTECTION (IP) rating, as in 6.3 below	IP 66	P
	– Ultraviolet (UV) exposure rating, as in 6.4 below		P
	– Ambient temperature and relative humidity ratings, as in 6.5 below	Max. 60°C, 100%R.H.	P
6.1	Environmental categories and minimum environmental conditions		P
6.1.1	Outdoor		P
6.1.2	Indoor, unconditioned		N/A
6.1.3	Indoor, conditioned		N/A
6.2	Pollution degree	PD3	P
6.3	Ingress Protection	IP66	P
6.4	UV exposure		P
6.5	Temperature and humidity	-30°C~+60°C, 0%~100% R.H.	P
7	PROTECTION AGAINST ELECTRIC SHOCK AND ENERGY HAZARDS		P
7.1	General		P
7.2	Fault conditions	Normal and single fault condition are considered	P
7.3	Protection against electric shock		P
7.3.1	General	In the PCE the earthed metal enclosure is evaluated by means of basic insulation from DVC C circuit DVC A circuit and unearthed accessible parts are evaluated by means of reinforced insulation from DVC C or protective impedance DVC C circuit: The PV input and the Main output DVC A circuit: The signal communication output port.	P
7.3.2	Decisive voltage classification		P
7.3.2.1	Use of decisive voltage class (DVC)	Working voltage and protective measure and considered	P
7.3.2.2	Limits of DVC (according table 6)	Wet location is considered for PCE outside only	P
7.3.2.3	Short-terms limits of accessible voltages under fault conditions		P
7.3.2.4	Requirements for protection (according table 7)	Single fault condition is considered	P

IEC 62109-1			
Clause	Requirement – Test	Result – Remark	Verdict
7.3.2.5	Connection to PELV and SELV circuits	The external signal communication ports are considered as SELV	P
7.3.2.6	Working voltage and DVC		P
7.3.2.6.1	General	Transients and voltage fluctuation are disregarded. And worst-case normal operation condition is considered	P
7.3.2.6.2	AC working voltage (see Figure 2)		P
7.3.2.6.3	DC working voltage (see Figure 3)		P
7.3.2.6.4	Pulsating working voltage (see Figure 4)		P
7.3.3	protective separation	In the PCE the earthed metal enclosure is evaluated by means of basic insulation from DVC C circuit DVC A circuit and unearthed accessible parts are evaluated by means of reinforced insulation from DVC C or protective impedance DVC C circuit: The PV input and the Main output DVC A circuit: The signal communication output port	P
	Protective separation shall be achieved by:		P
	<ul style="list-style-type: none"> ▪ double or reinforced insulation, or 	The double or reinforced insulation was provided between: 1) PV input circuits and communication circuits; 2) AC output circuits and communication circuits.	P
	<ul style="list-style-type: none"> ▪ protective screening, i.e. by a conductive screen connected to earth by protective bonding in the PCE, or connected to the protective earth conductor itself, whereby the screen is separated from live parts by at least basic insulation, or 		P
	<ul style="list-style-type: none"> ▪ protective impedance comprising limitation of current per 7.3.5.3 and of discharged energy per 7.3.5.4, or 		P
	<ul style="list-style-type: none"> ▪ limitation of voltage according to 7.3.5.4. 		N/A
	The protective separation shall be fully and effectively maintained under all conditions of intended use of the PCE		P
7.3.4	Protection against direct contact		P
7.3.4.1	General		P

IEC 62109-1			
Clause	Requirement – Test	Result – Remark	Verdict
	Protection against direct contact is employed to prevent persons from touching live parts that do not meet the requirements of 7.3.5 and shall be provided by one or more of the measure given in 7.3.4.2 (enclosures and barriers) and 7.3.4.3 (insulation).	Metal enclosure provides basic insulation and PE	P
	Open type sub-assemblies and devices do not require protective measures against direct contact but the instruction provided with the equipment must indicate that such measures must be provided in the end equipment or in the installation.		N/A
	Product intended for installation in CLOSED ELECTRICAL OPERATING AREAS, (see 3.9) need not have protective measures against direct contact, except as required by 7.3.4.2.4.	Not use under this condition	N/A
7.3.4.2	Protection by means of enclosures and barriers		P
	The following requirements apply where protection against contact with live parts is provided by enclosures or barriers, not by insulation in accordance with 7.3.4.3.	Enclosure provided to prevent access to inside live parts	P
7.3.4.2.1	General		P
	Parts of enclosures and barriers that provide protection in accordance with these requirements shall not be removable without the use of a tool (see 7.3.4.2.3).	Secured by screws	P
	Polymeric materials used to meet these requirements shall also meet the requirements of 13.6		N/A
7.3.4.2.2	Access probe criteria		P
	Protection is considered to be achieved when the separation between the test probes and live parts, when tested as described below, is as follows:		P
	a) decisive voltage classification A, (DVC A) - the probe may touch the live parts	The signal is considered as DVC A	P
	b) decisive voltage classification B, (DVC B) - the probe must not touch bare live parts	The DVC B circuit is not accessible by probe	P
	c) decisive voltage classification C, (DVC C) – the probe must have adequate clearance to live parts, based on the clearance for Basic insulation using the recurring peak working voltage involved,	The DVC C circuit is not accessible by probe	P
7.3.4.2.3	Access probe tests		P
	Compliance with 7.3.4.2.1 is checked by all of the following:		P
	a) Inspection; and		P
	b) Tests with the test finger (Figure D.1) and test		P

IEC 62109-1			
Clause	Requirement – Test	Result – Remark	Verdict
	pin (Figure D.2) of 0E, the results of which shall comply with the requirements of 7.3.4.2.1 a), b), and c) as applicable. Probe tests are performed on openings in the enclosures after removal of parts that can be detached or opened by an operator without the use of a tool, including fuseholders, and with operator access doors and covers open. It is permitted to leave lamps in place for this test. Connectors that can be separated by an operator without use of a tool, shall also be tested during and after disconnection. Any movable parts are to be put in the most unfavourable position.		
	The test finger and the test pin are applied as above, without appreciable force, in every possible position, except that floor-standing equipment having a mass exceeding 40 kg is not tilted.		P
	Equipment intended for building-in or rack mounting, or for incorporation in larger equipment, is tested with access to the equipment limited according to the method of mounting detailed in the installation instructions.		N/A
	c) Openings preventing the entry of the jointed test finger (Figure E-1 of 0E) during test b) above, are further tested by means of straight unjointed test finger (Figure E-3 of 0E), applied with a force of 30 N. If the unjointed finger enters, the test with the jointed finger is repeated except that the finger is applied using any necessary force up to 30 N.	No openings	N/A
	d) In addition to a) – c) above, top surfaces of enclosure shall be tested with the IP3X probe of IEC 60529. The test probe shall not penetrate the top surface of the enclosure when probed from the vertical direction $\pm 5^\circ$ only.		N/A
7.3.4.2.4	Service access areas	Inside PCE are not intentionally touched with energized part when installation and maintenance. Symbol 21 of Annex C are marked on PCE and explained in user manual	P
7.3.4.3	Protection by means of insulation of live parts	The earthed enclosure is with basic insulation form the live parts inside	N/A
	Where the requirements of 7.3.4.2 are not met, live parts shall be provided with insulation if:		N/A
	– their working voltage is greater than the		N/A

IEC 62109-1			
Clause	Requirement – Test	Result – Remark	Verdict
	maximum limit of decisive voltage class A, or		
	– for a DVC A or B circuit, protective separation from adjacent circuit of DVC C is not provided (see note “†” under Table 7)		N/A
7.3.5	Protection in case of direct contact	The single communication ports are direct contact and evaluated with reinforced insulation from live part	P
7.3.5.1	General		P
	Protection in case of direct contact is required to ensure that contact with live parts does not produce a shock hazard.		P
	The protection against direct contact according to 7.3.4 is not required if the circuit contacted is separated from other circuits according to 7.3.2.3, and:	Considered	P
	– is of decisive voltage class A and complies with 7.3.5.2, or	The single communication port is DVC A and reinforced insulation from the live part by means of isolation transformer and optocoupler	P
	– is provided with protective impedance according to 7.3.5.3, or		N/A
	– is limited in voltage according to 7.3.5.4		N/A
	In addition to the measures as given in 7.3.5.2 to 7.3.5.4, it shall be ensured that in the event of error or polarity reversal of connectors no voltages that exceed DVC A can be connected into a circuit with protective separation. This applies for example to plug-in-sub-assemblies or other plug-in devices which can be plugged-in without the use of a tool (key) or which are accessible without the use of a tool.	Considered	P
	Conformity is checked by visual inspection and trial insertion.		P
7.3.5.2	Protection using decisive voltage class A	The communication port is DVC A and reinforced insulation from the live part by means of isolation transformer and optocoupler	P
7.3.5.3	Protection by means of protective impedance	Protective impedance not used as protective separation in the PCE	N/A
	Circuits and conductive parts do not require protection against direct contact if any connection to circuits of DVC-B or DVC-C is through protective impedance, and the accessible circuit or part is otherwise provided with protective separation from		N/A

IEC 62109-1			
Clause	Requirement – Test	Result – Remark	Verdict
	circuits of DVC-B or DVC-C according 7.3.3.		
7.3.5.3.1	Limitation of current through protective impedance		N/A
	The current available through protective impedance to earth and between simultaneously accessible parts, measured at the accessible live parts, shall not exceed a value of 3,5 mA a.c. or 10 mA d.c. under normal and single-fault conditions.		N/A
7.3.5.3.2	Limitation of discharging energy through protective impedance		N/A
	The discharging energy available between simultaneously accessible parts protected by protective impedance shall not exceed the charging voltage and capacitance limits given in Table 9, which applies to both wet and dry locations, under normal and single fault conditions. Refer to figure 8.		N/A
7.3.5.4	Protection by means of limited voltages	No such design	N/A
	That portion of a circuit that has its voltage reduced to DVC-A by a voltage divider that complies with the following requirements, and that is otherwise provided with protective separation from circuits of DVC-B or DVC-C according to 7.3.3, does not require protection against direct contact.		N/A
	The voltage divider shall be designed so that under normal and single fault conditions, including faults in the voltage division circuit, the voltage across the output of the voltage divider does not exceed the limit for DVC-A.		N/A
	This type of protection shall not be used in case of protective class II or unearthed circuits, because it relies on protective earth being connected.		N/A
7.3.6	Protection against indirect contact		P
7.3.6.1	General		P
	Protection against indirect contact is required to prevent shock- hazardous current being accessible from conductive parts during an insulation failure. This protection shall comply with the requirements for protective class I (basic insulation plus protective earthing), class II (double or reinforced insulation) or class III (limitation of voltages)	The earthing metal enclosure is complied with protective class I and the circuit of communication is complied with protective class II for accessible communication ports	P
	That part of a PCE meets the requirements of 7.3.6.2 and 7.3.6.3 is defined as protective class I	The earthed metal enclosure meets this requirement	P
	That part of a PCE meets the requirements of 7.3.6.4 is defined as protective class II.		P
	That part of PCE which meets the requirements of decisive voltage class A and in which no hazardous voltages are derived, is defined as protective class III. No shock hazard is present in such circuits.		N/A

IEC 62109-1			
Clause	Requirement – Test	Result – Remark	Verdict
	Where protection against indirect contact is dependent on means provided during installation, the installation instructions shall provide details of the required means and shall indicate the associated hazards.	The manual requires the PCE must be securely earthed	P
7.3.6.2	Insulation between live parts and accessible conductive parts		P
	Accessible conductive parts of equipment shall be separated from live parts by insulation meeting the requirements of Table 7 or by clearances as specified in 7.3.7.4 and creepages as specified in 7.3.7.5	See Cl. 7.3.7.4 and Cl. 7.3.7.5	P
7.3.6.3	Protective class I – Protective bonding and earthing		P
7.3.6.3.1	General		P
	Equipment of protective class I shall be provided with protective earthing, and with protective bonding to ensure electrical contact between accessible conductive parts and the means of connection for the external protective earthing conductor, except bonding is not required for:		P
	a) accessible conductive parts that are protected by one of the measures in 7.3.5.2 to 7.3.5.4, or		P
	b) accessible conductive parts are separated from live parts of DVC-B or -C using double or reinforced insulation.	Communication circuits are separated from live parts used double or reinforced insulation	P
7.3.6.3.2	Requirements for protective bonding		P
	Electrical contact with the means of connection of the external protective earthing conductor shall be achieved by one or more of the following means:		P
	a) through direct metallic contact;	The connection of external protective earthing conductor is direct metal contact via a terminal with screw.	P
	b) through other conductive parts which are not removed when the PCE or sub-units are used as intended ;		N/A
	c) through a dedicated protective bonding conductor;		P
	d) through other metallic components of the PCE		N/A
	Where direct metallic contact is used and one or both of the parts involved is painted or coated, the paint or coating shall be removed in the area of contact, or reliably penetrated, to ensure metal to metal contact.	The metal enclosure is reliably penetrated earthed	P
	For moving or removable parts, hinges or sliding contacts designed and maintained to have a low resistance are examples of acceptable means if	No such design	N/A

IEC 62109-1			
Clause	Requirement – Test	Result – Remark	Verdict
	they comply with the requirements of 7.3.6.3.3.		
	Metal ducts of flexible or rigid construction and metallic sheaths shall not be used as protective bonding conductors, unless the device or material has been investigated as suitable for protective bonding purposes.	No such design	N/A
7.3.6.3.3	Rating of protective bonding	The alternative of 7.3.6.3.5 is considered.	P
	Protective bonding shall withstand the highest thermal and dynamic stresses that can occur to the PCE item(s) concerned when they are subjected to a fault connecting live parts to accessible conductive parts. The protective bonding shall remain effective for as long as a fault to the accessible conductive parts persists or until an upstream protective device removes power from the part.		P
	Protective bonding shall meet following requirements:		P
	a) For PCE with an overcurrent protective device rating of 16 A or less, the impedance of the protective bonding means shall not exceed 0,1 Ω during or at the end of the test below.		N/A
	b) For PCE with an overcurrent protective device rating of more than 16 A, the voltage drop in the protective bonding test shall not exceed 2,5 V during or at the end of the test below.		P
	As alternative to a) and b) the protective bonding may designed according to the requirements for the external protective earthing conductor in 7.3.6.3.5, in which case no testing is required.	The alternative of 7.3.6.3.5 is considered.	P
	The impedance of protective bonding means shall be checked by passing a test current through the bond for a period of time as specified below. The test current is based on the rating of the overcurrent protection for the equipment or part of the equipment under consideration, as follows:		N/A
	a) For pluggable equipment type A, the overcurrent protective device is that provided external to the equipment (for example, in the building wiring, in the mains plug or in an equipment rack);		N/A
	b) For pluggable equipment type B and fixed equipment, the maximum rating of the overcurrent protective device specified in the equipment installation instructions to be provided external to the equipment;		N/A
	c) For a circuit or part of the equipment for which an overcurrent protective device is provided as		N/A

IEC 62109-1			
Clause	Requirement – Test	Result – Remark	Verdict
	part of the equipment, the rating of the provided overcurrent device.		
	Voltages are measured from the protective earthing terminal to all parts whose protective bonding means are being considered. The impedance of the protective earthing conductor is not included in the measurement. However, if the protective earthing conductor is supplied with the equipment, it is permitted to include the conductor in the test circuit but the measurement of the voltage drop is made only from the main protective earthing terminal to the accessible part required to be earthed.		N/A
	On equipment where the protective earth connection to a subassembly or to a separate unit is part of a cable that also supplies power to that subassembly or unit, the resistance of the protective bonding conductor in that cable is not included in the protective bond impedance measurements for the subassembly or separate unit, as shown in Figure 11. However, this option is only permitted if the cable is protected by a suitably rated protective device that takes into account the size of the conductor. Otherwise the impedance of the protective bonding conductor between the separate units is to be included, by measuring to the protective earthing terminal where the power source enters the first unit in the system, as shown in Figure 12.		N/A
7.3.6.3.3.1	Test current, duration, and acceptance criteria		P
	The test current, duration of the test and acceptance criteria are as follows:		P
	a) For PCE with an overcurrent protective device rating of 16 A or less, the test current is 200% of the overcurrent protective device rating, but not less than 32 A, applied for 120s. The impedance of the protective bonding means during and at the end of the test shall not exceed 0,1 Ω.		N/A
	b) For PCE with an overcurrent protective device rating of more than 16 A, the test current is 200% of the overcurrent protective device rating and the duration of the test is as shown in Table 10 below. The voltage drop in the protective bonding means, during and at the end of the test, shall not exceed 2,5 V.		P
	c) During and after the test, there shall be no melting, loosening, or other damage that would impair the effectiveness of the protective bonding means.		P
	The test current is derived from an a.c or d.c supply		P

IEC 62109-1			
Clause	Requirement – Test	Result – Remark	Verdict
	source, the output of which is not earthed.		
	As an alternative to Table 10, where the time-current characteristic of the overcurrent protective device that limits the fault current in the protective bonding means is known because the device is either provided in the equipment or fully specified in the installation instructions, the test duration may be based on that specific device's time-current characteristic,. The tests are conducted for a duration corresponding to the 200% current value on the time-current characteristic.		N/A
7.3.6.3.4	Protective bonding impedance (routine test)	Manufacture declaration for this	N/A
	If the continuity of the protective bonding is achieved at any point by a single means only (for example a single conductor or single fastener), or if the PCE is assembled at the installation location, then the impedance of the protective bonding shall also be tested as a routine test. The test shall be as in 7.3.6.3.3, except for the following:		N/A
	<ul style="list-style-type: none"> the test current may be reduced to any convenient value greater than 10 A sufficient to allow measurement or calculation of the impedance of the protective bonding means: 		N/A
	<ul style="list-style-type: none"> the test duration may be reduced to no less than 2 s 		N/A
	For equipment subject to the type test in 7.3.6.3.3.1a), the impedance during the routine test shall not exceed 0,1Ω.		N/A
	For equipment subject to the type test in 7.3.6.3.3.1b) the impedance during the routine test shall not exceed 2,5 V divided by the test current required by 7.3.6.3.3.1b).		N/A
7.3.6.3.5	External protective earthing conductor		P
	A protective earthing conductor shall be connected at all times when power is supplied to PCE of protective class I. Unless local wiring regulations state otherwise, the protective earthing conductor cross-sectional area shall be determined from Table 11 or by calculation according to IEC 60364-5-54.	The protective earthing conductor is fixed permanently and the minimum cross-sectional area is 8mm ² cable of phase and protective earthing. Only qualified personnel can install the protective earthing.	P
	If the external protective earthing conductor is routed through a plug and socket or similar means of disconnection, it shall not be possible to disconnect it unless power is simultaneously removed from the part to be protected.	Permanently connected	N/A
	The cross-sectional area of every external		P

IEC 62109-1			
Clause	Requirement – Test	Result – Remark	Verdict
	protective earthing conductor which does not form part of the supply cable or cable enclosure shall, in any case, be not less than:		
	<ul style="list-style-type: none"> ▪ 2,5 mm² if mechanical protection is provided; 		N/A
	<ul style="list-style-type: none"> ▪ 4 mm² if mechanical protection is not provided. 		P
	For cord-connected equipment, provisions shall be made so that the external protective earthing conductor in the cord shall, in the case of failure of the strain-relief mechanism, be the last conductor to be interrupted.	Not cord-connected equipment.	N/A
7.3.6.3.6	Means of connection for the external protective earthing conductor	External protective earthing conductors connect to the enclosure body.	P
7.3.6.3.6.1	General		P
	<p>The means of connection for the external protective earthing conductor shall be located near the terminals for the respective live conductors. The means of connections shall be corrosion-resistant and shall be suitable for the connection of cables according to 7.3.6.3.5.</p> <p>The means of connection for the protective earthing conductor shall not be used as a part of the mechanical assembly of the equipment or for other connections.</p> <p>A separate means of connection shall be provided for each external protective earthing conductor.</p> <p>Connection and bonding points shall be so designed that their current-carrying capacity is not impaired by mechanical, chemical, or electrochemical influences. Where enclosures and/or conductors of aluminium or aluminium alloys are used, particular attention should be given to the problems of electrolytic corrosion.</p>	Considered	P
	The means of connection for the protective earthing conductor shall be permanently marked with:		P
	<ul style="list-style-type: none"> • symbol 7 of Annex C; or 		P
	<ul style="list-style-type: none"> • the colour coding green-yellow 		P
	Marking shall not be done on easily changeable parts such as screws.		P
7.3.6.3.7	Touch current in case of failure of the protective earthing conductor		P
	The requirements of this sub-clause shall be satisfied to maintain safety in case of damage to or disconnection of the protective earthing conductor.		P
	For pluggable equipment type A, the touch current measured in accordance with 7.5.4 shall not exceed 3,5 mA a.c. or mA d.c.		N/A

IEC 62109-1			
Clause	Requirement – Test	Result – Remark	Verdict
	For all other PCE, one or more of the following measure shall be applied, unless the touch current measured in accordance with 7.5.4 using the test network of IEC 60990 test figure 4 shall not exceed 3,5 mA a.c. or 10 mA d.c.	Accessible parts and earthing terminal: 7.2mAac	P
	a) Permanently connected wiring, and:	Have	P
	<ul style="list-style-type: none"> a cross-section of the protective earthing conductor of at least 10 mm² Cu or 16 mm² Al; or 		P
	<ul style="list-style-type: none"> automatic disconnection of the supply in case of discontinuity of the protective earthing conductor; or 		N/A
	<ul style="list-style-type: none"> provision of an additional terminal for a second protective earthing conductor of the same cross-sectional area as the original protective earthing conductor and installation instruction requiring a second protective earthing conductor to be installed or 		P
	b) Connection with an industrial connector according to IEC 60309 and a minimum protective earthing conductor cross-section of 2,5 mm ² as part of a multi-conductor power cable. Adequate strain relief shall be provided.		N/A
	In addition, the caution symbol 15 of Annex C shall be fixed to the product and the installation manual shall provide details of the protective earthing measures required in the installation as required in 5.3.2.		P
	When it is intended and allowed to connect two or more PCEs in parallel using one common PE conductor, the above touch current requirements apply to the maximum number of the PCEs to be connected in parallel, unless one of the measures in a)		N/A
	or b) above is used. The maximum number of parallel PCEs is used in the testing and has to be stated in the installation manual.		N/A
7.3.6.4	Protective Class II – Double or Reinforced Insulation	Class I	N/A
	Equipment or parts of equipment designed for protective class II shall have insulation between live parts and accessible surfaces in accordance with 7.3.4.3. The following requirements also apply:	Signal communication ports are evaluated with reinforced insulation form live parts inside	N/A
	<ul style="list-style-type: none"> Equipment designed to protective class II shall not have means of connection for the external protective earthing conductor. However this does not apply if the external protective 		N/A

IEC 62109-1			
Clause	Requirement – Test	Result – Remark	Verdict
	earthing conductor is passed through the equipment to equipment series-connected beyond it. In the latter event, the external protective earthing conductor and its means for connection shall be insulated with basic insulation from the accessible surface of the equipment and from circuits that employ protective separation, extra-low voltage, protective impedance and limited discharging energy, according to 7.3.5. This basic insulation shall correspond to the rated voltage of the series-connected equipment;		
	<ul style="list-style-type: none"> metal-encased equipment of protective class II may have provision on its enclosure for the connection of an equipotential bonding conductor; 		N/A
	<ul style="list-style-type: none"> equipment of protective class II may have provision for the connection of an earthing conductor for functional reasons or for damping of overvoltages; it shall, however, be insulated as though it is a live part; 		N/A
	<ul style="list-style-type: none"> equipment employing protective class II shall be marked according to 5.1.8. 		N/A
7.3.7	Insulation Including Clearance and Creepage Distance		P
7.3.7.1	General		P
	This subclause gives minimum requirements for insulation, based on the principles of IEC 60664.	Considered	P
	Manufacturing tolerances shall be taken into account during measurement of creepage, clearance, and insulation distance in the PCE.	Considered	P
	Insulation shall be selected after consideration of the following influences:	Considered	P
	<ul style="list-style-type: none"> pollution degree 	PD3 outside, PD2 inside	P
	<ul style="list-style-type: none"> overvoltage category 	The mains circuits: OVC III The PV circuits: OVC II	P
	<ul style="list-style-type: none"> supply earthing system 	TN	P
	<ul style="list-style-type: none"> insulation voltage 	PV input: max. 1100Vdc and Main:314Vac	P
	<ul style="list-style-type: none"> location of insulation 	See table 7.3.7.4 and 7.3.7.5 for detail	P
	<ul style="list-style-type: none"> type of insulation 	See table 7.3.7.4 and 7.3.7.5 for detail	P
	Compliance of insulation, creepage distances, and clearance distances, shall be verified by measurement or visual inspection, and the tests of 7.5.		P

IEC 62109-1			
Clause	Requirement – Test	Result – Remark	Verdict
7.3.7.1.3	Supply earthing systems		P
	Three basic types of earthing system are described in IEC 60364-1. They are:	Inverter is intended to install in TN system	P
	<ul style="list-style-type: none"> TN system: has one point directly earthed, the accessible conductive parts of the installation being connected to that point by protective conductors. Three types of TN systems, TN-C, TN-S and TN-C-S, are defined according to the arrangement of the neutral and protective conductor. 		P
	<ul style="list-style-type: none"> TT system: has one point directly earthed, the accessible conductive parts of the installation being connected to earth electrodes electrically independent of the earth electrodes of the power system; 		N/A
	<ul style="list-style-type: none"> IT system: has all live parts isolated from earth or one point connected to earth through an impedance, the accessible conductive parts of the installation being earthed independently or collectively to the earthing system. 		N/A
7.3.7.1.4	Insulation voltages	See table 7.3.7.4 and 7.3.7.5 for detail	P
	Table 12 makes use of the circuit system voltage and overvoltage category to define the impulse withstands voltage and the temporary overvoltage.		P
7.3.7.2	Insulation between a circuit and its surroundings		P
7.3.7.2.1	General		P
7.3.7.2.2	Circuits connected directly to the mains	System voltage for mains is 314Vrms according to table 1	P
7.3.7.2.3	Circuits other than mains circuits		P
7.3.7.2.4	Insulation between circuits		P
7.3.7.3	Functional insulating		P
7.3.7.4	Clearance distances	(see appended table 7.3.7)	P
7.3.7.4.1	Determination	Designed for use in altitudes 4000m and below.	P
7.3.7.4.2	Electric field homogeneity	Inhomogeneous electric field is considered for PCE	N/A
7.3.7.4.3	Clearance to conductive enclosures		P
7.3.7.5	Creepage distances	(see appended table 7.3.7)	P
7.3.7.5.1	General		P
7.3.7.5.2	Voltage	If Working voltage less than system voltage, system voltage is used for creepage according to IEC60664-1	P

IEC 62109-1			
Clause	Requirement – Test	Result – Remark	Verdict
7.3.7.5.3	Materials	Certified PWB used. Other materials are considered IIIb. The inside parts are considered Pollution degree 2	P
7.3.7.6	Coating		N/A
7.3.7.7	PWB spacings for functional insulating	V-0 and short circuit test are considered	P
7.3.7.8	Solid insulating	(see appended table 7.3.7)	P
7.3.7.8.1	General		P
7.3.7.8.2	Requirements for electrical withstand capability of solid insulation		P
7.3.7.8.2.1	Basic, supplemental, reinforced, and double insulation		P
7.3.7.8.2.2	Functional insulation		P
7.3.7.8.3	Thin sheet or tape material		P
7.3.7.8.3.1	General		P
7.3.7.8.3.2	Material thickness not less than 0,2 mm	Impulse test and voltage test are considered for insulation on IGBT as basic insulation	P
7.3.7.8.3.3	Material thickness less than 0,2 mm		N/A
7.3.7.8.3.4	Compliance		N/A
7.3.7.8.4	Printed wiring boards		P
7.3.7.8.4.1	General		P
7.3.7.8.4.2	Use of coating materials		N/A
7.3.7.8.5	Wound components	Varnish is not considered as insulation and voltage test performed as routine test.	P
7.3.7.8.6	Potting materials		N/A
7.3.7.9	Insulation requirements above 30 kHz		N/A
7.3.8	Residual Current-operated protective (RCD) or monitoring (RCM) device compatibility	Internal RCM is used. An external built RCD is not necessary	P
	RCD and RCM are used to provide protection against insulation faults in some domestic and industrial installations, additional to that provided by the installed equipment.		N/A
7.3.9	Capacitor discharge		P
7.3.9.1	Operator access area	Accessible signal communication ports are DVC-A circuit.	P
	Equipment shall be so designed that there is no risk of electric shock in operator access areas from		P

IEC 62109-1			
Clause	Requirement – Test	Result – Remark	Verdict
	charge stored on capacitors after disconnection of the PCE.		
7.3.9.2	Service access areas	Inside capacitor discharge to DVC A and no energy hazard level within 300s	P
	Capacitors located behind panels that are removable for servicing, installation, or disconnection shall present no risk of electric shock or energy hazard from charge stored on capacitors after disconnection of the PCE.	Warning symbol 21 of annex C is marked on PCE with 5min.	P
7.4	Protection against energy hazards		P
7.4.1	Determination of hazardous energy level	No such high energy level presented in the operator access area.	P
	A hazardous energy level is considered to exist if		P
	a) The voltage is 2 V or more, and power available after 60 s exceeds 240 VA.	Considered	P
	b) The stored energy in a capacitor is at a voltage. U of 2 V or more, and the stored energy. E, calculated from the following equation, exceeds 20J: $E = 0,5 CU^2$	Considered	P
7.4.2	Operator Access Areas	No energized parts accessible to user	P
	Equipment shall be so designed that there is no risk of energy hazard in operator access areas from accessible circuits.		P
7.4.3	Services Access Areas	The capacitor inside the equipment stored hazardous energy. A symbol 21 of Annex C is provided.	P
7.5	Electrical tests related to shock hazard	(see appended table 7.5)	P
7.5.1	Impulse voltage test (type test)		P
7.5.2	Voltage test (dielectric strength test)		P
7.5.2.1	Purpose of test		P
7.5.2.2	Value and type of test voltage		P
7.5.2.3	Humidity pre-conditioning		P
7.5.2.4	Performing the voltage test		P
7.5.2.5	Duration of the a.c. or d.c. voltage test		P
7.5.2.6	Verification of the a.c. or d.c. voltage test		P
7.5.3	Partial discharge test		P
7.5.4	Touch current measurement (type test)		P

IEC 62109-1			
Clause	Requirement – Test	Result – Remark	Verdict
	The touch current shall be measured if required by 7.3.6.3.7 and shall not be greater than 3.5 mA a.c. or 10 mA d.c. or special measures of protection as given in 7.3.6.3.7 are required.	(see appended table 7.3.6.3.7)	P
	For type tests on PCE for which wet locations requirements apply according to 6.1, the humidity pre-conditioning of 4.5 shall be performed immediately prior to the touch current test.		P
7.5.5	Equipment with multiple sources of supply		P
8	PROTECTION AGAINST MECHANICAL HAZARDS		P
8.1	General		P
	Operation shall not lead to a mechanical HAZARD in NORMAL CONDITION or SINGLE FAULT CONDITION. Edges, projections, corners, openings, guards, handles and the like, that are accessible to the operator shall be smooth and rounded so as not to cause injury during normal use of the equipment.	No mechanical hazards under the normal or single fault condition.	P
	Conformity is checked as specified in 8.2 to 8.6.		P
8.2	Moving parts		P
	Moving parts shall not be able to crush, cut or pierce parts of the body of an OPERATOR likely to contact them, nor severely pinch the OPERATOR's skin. Hazardous moving parts of equipment, that is moving parts which have the potential to cause injury, shall be so arranged, enclosed or guarded as to provide adequate protection against the risk of personal injury.		P
8.2.1	Protection of service persons		P
	Protection shall be provided such that unintentional contact with hazardous moving parts is unlikely during servicing operations. If a guard over a hazardous moving part may need to be removed for servicing, the marking of symbol 15 of Table D-1 shall be applied on or near the guard.		P
8.3	Stability		N/A
	Equipment and assemblies of equipment not secured to the building structure before operation shall be physically stable in NORMAL USE.	Wall mounted	N/A
8.4	Provisions for lifting and carrying		P
	If carrying handles or grips are fitted to, or supplied with, the equipment, they shall be capable of withstanding a force of four times the weight of the equipment.		P
	Equipment or parts having a mass of 18 kg or more shall be provided with a means for lifting and		P

IEC 62109-1			
Clause	Requirement – Test	Result – Remark	Verdict
	carrying or directions shall be given in the manufacturer's documentation.		
8.5	Wall mounting		P
	Mounting brackets on equipment intended to be mounted on a wall or ceiling shall withstand a force of four times the weight of the equipment.		P
8.6	Expelled parts		N/A
	Equipment shall contain or limit the energy of parts that could cause a HAZARD if expelled in the event of a fault.		N/A
9	PROTECTION AGAINST FIRE HAZARDS		P
9.1	Resistance to fire		P
	This subclause specifies requirements intended to reduce the risk of ignition and the spread of flame, both within the equipment and to the outside, by the appropriate use of materials and components and by suitable construction.	Considered	P
9.1.1	Reducing the risk of ignition and spread of flame		P
	For equipment or a portion of equipment, there are two alternative methods of providing protection against ignition and spread of flame that could affect materials, wiring, wound components and electronic components such as integrated circuits, transistors, thyristors, diodes, resistors and capacitors.	Method 1 used	P
9.1.2	Conditions for a fire enclosure		P
	A FIRE ENCLOSURE is required for equipment or parts of equipment for which Method 2 is not fully applied and complied with.		P
9.1.2.1	Parts requiring a fire enclosure		P
	Except where Method 2 is used, or as permitted in 9.1.2.2, the following are considered to have a risk of ignition and, therefore, require a FIRE ENCLOSURE:		P
	– components in PRIMARY CIRCUITS		P
	– components in SECONDARY CIRCUITS supplied by power sources which exceed the limits for a LIMITED POWER SOURCE as specified in 9.2;		P
	– components in SECONDARY CIRCUITS supplied by a LIMITED POWER SOURCE as specified in 9.2, but not mounted on a material of FLAMMABILITY CLASS V-1;		N/A
	– components within a power supply unit or assembly having a limited power output		N/A

IEC 62109-1			
Clause	Requirement – Test	Result – Remark	Verdict
	complying with the criteria for a LIMITED POWER SOURCE as specified in 9.2, including overcurrent protective devices, limiting impedances, regulating networks and wiring, up to the point where the LIMITED POWER SOURCE output criteria are met;		
	– components having unenclosed arcing parts, such as open switch and relay contacts and commutators, in a circuit at HAZARDOUS VOLTAGE or at a HAZARDOUS ENERGY LEVEL; and	Enclosed relay	N/A
	– insulated wiring, except as permitted in 9.1.2.2.	PVC wire	N/A
9.1.2.2	Parts not requiring a fire enclosure		N/A
9.1.3	Materials requirements for protection against fire hazard		P
9.1.3.1	General		P
	ENCLOSURES, components and other parts shall be so constructed, or shall make use of such materials, that the propagation of fire is limited.		P
9.1.3.2	Materials for fire enclosures		P
	If an enclosure material is not classified as specified below, a test may be performed on the final enclosure or part of the enclosure, in which case the material shall additionally be subjected to periodic SAMPLE testing.	Metal enclosure	P
9.1.3.3	Materials for components and other parts outside fire enclosures		P
	Except as otherwise noted below, materials for components and other parts (including MECHANICAL ENCLOSURES, ELECTRICAL ENCLOSURES and DECORATIVE PARTS); located outside FIRE ENCLOSURES, shall be of FLAMMABILITY CLASS HB.		P
9.1.3.4	Materials for components and other parts inside fire enclosures		P
9.1.3.5	Materials for air filter assemblies		N/A
9.1.4	Openings in fire enclosures	No openings	N/A
9.1.4.1	General		N/A
	For equipment that is intended to be used or installed in more than one orientation as specified in the product documentation, the following requirements apply in each orientation.		N/A
	These requirements are in addition to those in the following sections:		N/A
	– 7.3.4, Protection against direct contact;		N/A

IEC 62109-1			
Clause	Requirement – Test	Result – Remark	Verdict
	– 7.4, Protection against energy hazards;		N/A
	– 13.5, Openings in enclosures		N/A
9.1.4.2	Side openings treated as bottom openings		N/A
9.1.4.3	Openings in the bottom of a fire enclosure		N/A
	The bottom of a FIRE ENCLOSURE or individual barriers, shall provide protection against emission of flaming or molten material under all internal parts, including partially enclosed components or assemblies, for which Method 2 of 9.1.1 has not been fully applied and complied with.		N/A
9.1.4.4	Equipment for use in a CLOSED ELECTRICAL OPERATING AREA		N/A
	The requirements of 9.1.4.3 do not apply to FIXED EQUIPMENT intended only for use in a CLOSED ELECTRICAL OPERATING AREA and to be mounted on a concrete floor or other non-combustible surface. Such equipment shall be marked as follows:		N/A
	WARNING: FIRE HAZARD SUITABLE FOR MOUNTING ON CONCRETE OR OTHER NON-COMBUSTIBLE SURFACE ONLY		N/A
9.1.4.5	Doors or covers in fire enclosures		N/A
9.1.4.6	Additional requirements for openings in transportable equipment		N/A
9.2	LIMITED POWER SOURCES		N/A
9.2.1	General		N/A
9.2.2	Limited power source tests		N/A
9.3	Short-circuit and overcurrent protection		P
9.3.1	General		P
	The PCE shall not present a hazard, under short-circuit or overcurrent conditions at any port, including phase-to-phase, phase-to-earth and phase-to-neutral, and adequate information shall be provided to allow proper selection of external wiring and external protective devices.	The circumstances of short-circuit and overcurrent are protected by the circuits design. When short-circuit or overcurrent of components occurred, the PCE will shutdown and disconnect from the grid immediately.	P
9.3.2	Protection against short-circuits and overcurrents shall be provided for all input circuits, and for output circuits that do not comply with the requirements for limited power sources in 9.2, except for circuits in which no overcurrent hazard is presented by short-circuits and overloads.	DC wire are designed for the short circuit rating of the array Short-circuit was occurred at PV input and DC terminal	P
9.3.3	Protective devices provided or specified shall have adequate breaking capacity to interrupt the		P

IEC 62109-1			
Clause	Requirement – Test	Result – Remark	Verdict
	maximum short circuit current specified for the port to which they are connected. If protection that is provided integral to the PCE for an input port is not rated for the short-circuit current of the circuit in which it is used, the installation instructions shall specify that an upstream protective device, rated for the prospective short-circuit current of that port, shall be used to provide backup protection.		
10	PROTECTION AGAINST SONIC PRESSURE HAZARDS		N/A
10.1	General		N/A
	The equipment shall provide protection against the effect of sonic pressure. Conformity tests are carried out if the equipment is likely to cause such HAZARDS.	No sonic pressure hazards.	N/A
10.2	Sonic pressure and Sound level		N/A
10.2.1	Hazardous Noise Levels		N/A
11	PROTECTION AGAINST LIQUID HAZARDS		N/A
11.1	Liquid Containment, Pressure and Leakage		N/A
	The liquid containment system components shall be compatible with the liquid to be used.		N/A
	There shall be no leakage of liquid onto live parts as a result of:		N/A
	a) Normal operation, including condensation;		N/A
	b) Servicing of the equipment; or		N/A
	c) Inadvertent loosening or detachment of hoses or other cooling system parts over time.		N/A
11.2	Fluid pressure and leakage		N/A
11.2.1	Maximum pressure		N/A
11.2.2	Leakage from parts		N/A
11.2.3	Overpressure safety device		N/A
11.3	Oil and grease		N/A
12	CHEMICAL HAZARDS		N/A
12.1	General		N/A
13	PHYSICAL REQUIREMENTS		P
13.1	Handles and manual controls		P
	Handles, knobs, grips, levers and the like shall be reliably fixed so that they will not work loose in normal use, if this might result in a hazard. Sealing compounds and the like, other than self-hardening resins, shall not be used to prevent loosening. If handles, knobs and the like are used to indicate the position of switches or similar components, it shall not be possible to fix them in a wrong position if this	DC breaker holder for manual controls.	P

IEC 62109-1			
Clause	Requirement – Test	Result – Remark	Verdict
	might result in hazard.		
13.1.1	Adjustable controls	No such setting control	N/A
13.2	Securing of parts		P
13.3	Provisions for external connections		P
13.3.1	General	Certified PV connectors are used. AC terminal provided for grid connection and secured by a cable gland. Installation manual provide information for the disconnection means	P
13.3.2	Connection to an a.c. Mains supply	AC terminal used, and it is detachable with tool	P
13.3.2.1	General		P
	For safe and reliable connection to a MAINS supply, equipment shall be provided with one of the following:	See above	P
	– terminals or leads or a non-detachable power supply cord for permanent connection to the supply; or		P
	– a non-detachable power supply cord for connection to the supply by means of a plug		N/A
	– an appliance inlet for connection of a detachable power supply cord; or		N/A
	– a mains plug that is part of direct plug-in equipment as in 13.3.8		N/A
13.3.2.2	Permanently connected equipment		P
13.3.2.3	Appliance inlets		N/A
13.3.2.4	Power supply cord		N/A
13.3.2.5	Cord anchorages and strain relief	Cable gland used	N/A
	For equipment with a non-detachable power supply cord, a cord anchorage shall be supplied such that:		N/A
	– the connecting points of the cord conductors are relieved from strain; and		N/A
	– the outer covering of the cord is protected from abrasion.		N/A
13.3.2.6	Protection against mechanical damage		N/A
13.3.3	Wiring terminals for connection of external conductors	AC terminals for connection of external conductors.	P
13.3.3.1	Wiring terminals		P
13.3.3.2	Screw terminals		P
13.3.3.3	Wiring terminal sizes		P

IEC 62109-1			
Clause	Requirement – Test	Result – Remark	Verdict
13.3.3.4	Wiring terminal design		P
13.3.3.5	Grouping of wiring terminals		P
13.3.3.6	Stranded wire		P
13.3.4	Supply wiring space		P
13.3.5	Wire bending space for wires 10 mm ² and greater		P
13.3.6	Disconnection from supply sources	The explanations are provided in the installation manual.	P
13.3.7	Connectors plugs and sockets	The misconnection is unlikely for PV connectors.	P
13.3.8	Direct plug-in equipment	Permanently equipment.	N/A
13.4	Internal wiring and connections		P
13.4.1	General	All wires were used suitably and are fixed well to prevent mechanical damage during installation.	P
13.4.2	Routing	Internal wire is routed to avoid sharp edge and overheat	P
13.4.3	Colour coding	Green-yellow wire used as protective bonding only	P
13.4.4	Splices and connections		P
13.4.5	Interconnections between parts of the PCE		P
13.5	Openings in enclosures		N/A
13.5.1	Top and side openings		N/A
	Openings in the top and sides of ENCLOSURES shall be so located or constructed that it is unlikely that objects will enter the openings and create hazards by contacting bare conductive parts.		N/A
13.6	Polymeric Materials		P
13.6.1	General		P
13.6.1.1	Thermal index or capability		P
13.6.2	Polymers serving as enclosures or barriers preventing access to hazards		P
13.6.2.1	Stress relief test		P
13.6.3	Polymers serving as solid insulation		P
13.6.3.1	Resistance to arcing		N/A
13.6.4	UV resistance		P
	Polymeric parts of an OUTDOOR ENCLOSURE required for compliance with this standard shall be sufficiently resistance to degradation by ultra-violet (UV) radiation	The LCD panel rated UV resistance according to UL 746C	P

IEC 62109-1			
Clause	Requirement – Test	Result – Remark	Verdict

13.7	Mechanical resistance to deflection, impact, or drop		P
13.7.1	General		P
13.7.2	250-N deflection test for metal enclosures		P
13.7.3	7-J impact test for polymeric enclosures		P
13.7.4	Drop test		N/A
13.8	Thickness requirements for metal enclosures		N/A
13.8.1	General	The enclosure complied with 13.7.	P
13.8.2	Cast metal		N/A
13.8.3	Sheet metal		P

14	COMPONENTS		P
14.1	General	(see appended table 14)	P
	Where safety is involved, components shall be used in accordance with their specified RATINGS unless a specific exception is made. They shall conform to one of the following:		P
	a) applicable safety requirements of a relevant IEC standard. Conformity with other requirements of the component standard is not required. If necessary for the application, components shall be subjected to the test of this standard, except that it is not necessary to carry out identical or equivalent tests already performed to check conformity with the component standard;		P
	b) the requirements of this standard and, where necessary for the application, any additional applicable safety requirements of the relevant IEC component standard;		P
	c) if there is no relevant IEC standard, the requirements of this standard;		P
	d) applicable safety requirements of a non-IEC standard which are at least as high as those of the applicable IEC standard, provided that the component has been approved to the non-IEC standard by a recognized testing authority.		P
	Components such as optocouplers, capacitors, transformers, and relays connected across basic, supplemental, reinforced, or double insulation shall comply with the requirements applicable for the grade of insulation being bridged, and if not previously certified to the applicable component safety standard shall be subjected to the voltage test of 7.5.2 as routine test.		P

IEC 62109-1			
Clause	Requirement – Test	Result – Remark	Verdict
14.2	Motor Over temperature Protection		N/A
	Motors which, when stopped or prevented from starting (see 4.4.4.3), would present an electric shock HAZARD, a temperature HAZARD, or a fire HAZARD, shall be protected by an over temperature or thermal protection device meeting the requirements of 14.3.		N/A
14.3	Over temperature protection devices		N/A
14.4	Fuse holders		N/A
14.5	MAINS voltage selecting devices		N/A
14.6	Printed circuit boards		P
	Printed circuit boards shall be made of material with a flammability classification of V-1 of IEC 60707 or better.	V-0	P
	This requirement does not apply to thin-film flexible printed circuit boards that contain only circuits powered from limited power sources meeting the requirements of 9.2.		P
	Conformity of the flammability RATING is checked by inspection of data on the materials. Alternatively, conformity is checked by performing the V-1 tests specified in IEC 60707 on three samples of the relevant parts.		P
14.7	Circuits or components used as transient overvoltage limiting devices		N/A
	If control of transient overvoltage is employed in the equipment, any overvoltage limiting component or circuit shall be tested with the applicable impulse withstand voltage of Table 7-10 using the test method from 7.5.1 except 10 positive and 10 negative impulses are to be applied and may be spaced up to 1 min apart.		N/A
14.8	Batteries		N/A
	Equipment containing batteries shall be designed to reduce the risk of fire, explosion and chemical leaks under normal conditions and after a single fault in the equipment including a fault in circuitry within the equipment battery pack.		N/A
14.8.1	Battery Enclosure Ventilation		N/A
14.8.1.1	Ventilation requirements		N/A
14.8.1.2	Ventilation testing		N/A
14.8.1.3	Ventilation instructions		N/A
14.8.2	Battery Mounting		N/A
	Compliance is verified by the application of the force to the battery's mounting surface. The test force is to be increased gradually so as to reach the		N/A

IEC 62109-1			
Clause	Requirement – Test	Result – Remark	Verdict
	required value in 5 to 10 s, and is to be maintained at that value for 1 min. A non-metallic rack or tray shall be tested at the highest normal condition operating temperature.		
14.8.3	Electrolyte spillage		N/A
	Battery trays and cabinets shall have an electrolyte-resistant coating.		N/A
	The ENCLOSURE or compartment housing a VENTED BATTERY shall be constructed so that spillage or leakage of the electrolyte from one battery will be contained within the ENCLOSURE and be prevented from:		N/A
	a) reaching the PCE outer surfaces that can be contacted by the USER		N/A
	b) contaminating adjacent electrical components or materials; and		N/A
	c) bridging required electrical distances		N/A
14.8.4	Battery Connections		N/A
	Reverse battery connection of the terminals shall be prevented if reverse connection could result in a hazard within the meaning of this Standard		N/A
14.8.5	Battery maintenance instructions		N/A
	The information and instructions listed in 5.3.4.1 shall be included in the operator manual for equipment in which battery maintenance is performed by the operator, or in the service manual if battery maintenance is to be performed by service personnel only.		N/A
14.8.6	Battery accessibility and maintainability		N/A
	Battery terminals and connectors shall be accessible for maintenance with the correct TOOLS. Batteries with liquid electrolyte, requiring maintained shall be so located that the battery cell caps are accessible for electrolyte tests and readjusting of electrolyte levels.		N/A
15	Software and firmware performing safety functions	Refer to annex B for details	P

IEC 62109-1			
Clause	Requirement – Test	Result – Remark	Verdict
Annex A	Measurement of clearances and creepage distances (see 7.3.7.4 and 7.3.7.5)		P
Annex B	Programmable Equipment		P
B.1	Software or firmware that perform safety critical functions		P
B.1.1	Firmware or software that performs a critical safety function/s, the failure of which can result in a risk of fire, electric shock or other hazard as specified by this standard, shall be evaluated by one of the following means.		P
	a) All software or firmware limits or controls shall be disabled before the test to evaluate the hardware circuitry during the abnormal test condition related to the safety function.		P
	b) Protective controls employing software or firmware to perform their function(s), shall be so constructed that they comply with IEC 60730-1 Annex H to address the risks identified in B.2.1.		N/A
B.2	Evaluation of controls employing software		P
Annex C	Symbols to be used in equipment markings		P
Annex D	Test Probes for Determining Access		P
Annex E	RCDs	Integrated RCM used	N/A
Annex F	Altitude correction for clearances		N/A
Annex G	Clearance and creepage distance determination for frequencies greater than 30 kHz	Only clock for IC	P
Annex H	Measuring Instrument for Touch Current Measurements		P
H.1	Measuring instrument		P
H.2	Alternative measuring instrument		N/A
Annex I	Examples of Protection, Insulation, and Overvoltage Category Requirements for PCE		P
Annex J	Ultraviolet light conditioning test		N/A

IEC 62109-1			
Clause	Requirement – Test	Result – Remark	Verdict

4.2.2.6/4.7 TABLE: mains supply electrical data in normal condition/ Electrical ratings test						P
Type	U (V)	I (A) DC	P (KW) DC	U (V)	I (A) AC	P (KW) AC
iMars XG100KTR	529.98	195.28	103.488	207.60 207.67 207.78	162.64 160.67 160.30	100.419
iMars XG100KTR	528.42	196.56	102.829	230.65 231.07 230.66	147.53 144.52 142.41	100.079
iMars XG100KTR	529.93	192.74	102.126	253.48 253.53 253.63	132.48 129.97 129.77	99.412
iMars XG100KTR	620.00	167.38	103.767	207.60 207.67 207.79	163.88 161.83 161.44	101.156
iMars XG100KTR	616.75	165.56	102.014	230.66 231.07 230.67	147.03 144.08 141.92	99.718
iMars XG100KTR	619.98	164.32	101.866	253.48 253.53 253.62	132.55 130.00 129.75	99.429
iMars XG100KTR	850.01	121.26	103.055	207.60 207.67 207.78	162.37 160.58 160.04	100.285
iMars XG100KTR	843.66	120.90	101.824	230.74 231.12 230.73	144.53 144.52 142.25	99.495
iMars XG100KTR	850.00	121.19	103.000	253.49 253.54 253.64	133.76 131.36 131.01	100.395
iMars XG136KTR-L	561.70	244.38	137.264	249.98 250.03 250.14	178.69 177.17 176.91	133.193
iMars XG136KTR-L	578.70	246.14	139.625	277.70 278.20 277.69	165.28 163.09 161.67	135.903
iMars XG136KTR-L	561.61	250.05	140.421	304.76 304.81 304.90	150.75 148.75 148.66	136.566
iMars XG136KTR-L	729.79	187.39	136.748	249.69 249.74 249.85	179.48 177.91 177.62	133.599
iMars XG136KTR-L	725.66	193.06	139.967	277.72 278.22 277.71	166.21 163.97 162.56	136.607
iMars XG136KTR-L	729.73	191.52	139.749	304.76 304.80 304.90	150.85 148.80 148.63	136.600

IEC 62109-1						
Clause	Requirement – Test			Result – Remark		Verdict

iMars XG136KTR-L	849.86	162.99	138.500	249.69 249.75 249.86	181.35 180.01 179.53	135.063
iMars XG136KTR-L	849.84	163.45	138.890	277.62 277.67 277.77	164.54 162.86 162.55	136.018
iMars XG136KTR-L	849.84	165.19	140.375	304.77 304.81 304.91	151.54 149.58 149.43	137.265
iMars XG136KTR-X	559.72	250.69	140.251	279.60 279.65 279.75	163.82 162.03 161.83	136.356
iMars XG136KTR-X	559.67	249.94	139.873	311.54 311.58 311.67	147.05 145.00 144.86	136.092
iMars XG136KTR-X	559.62	249.87	139.813	342.48 342.52 342.61	134.04 131.71 131.61	136.043
iMars XG136KTR-X	779.86	179.77	140.191	279.60 279.66 279.76	164.36 162.63 162.35	136.817
iMars XG136KTR-X	799.84	179.31	139.826	311.54 311.58 311.68	147.91 145.80 145.57	136.835
iMars XG136KTR-X	779.80	178.39	139.099	342.48 342.52 342.61	134.33 131.86 131.72	136.234
iMars XG136KTR-X	849.88	163.37	138.827	280.61 280.66 280.75	162.86 161.14 160.89	136.058
iMars XG136KTR-X	849.90	163.57	138.998	311.54 311.58 311.67	147.79 145.53 145.41	136.660
iMars XG136KTR-X	849.86	163.97	139.345	342.49 342.52 342.62	134.74 132.27 132.14	136.656

IEC 62109-1			
Clause	Requirement – Test	Result – Remark	Verdict

4.3 TABLE: Thermal testing					P
Model :	iMars XG136KTR-L				—
temperature t of part/at:	t (°C)				permitted t (°C)
test Condition :	PV input: 530Vdc, 263.0A AC output: 277.1Vac 163.9A, 277.1Vac 164.9A, 277.1Vac 164.8A	PV input: 850.1Vdc, 164.5A AC output: 277.1Vac 164.7A, 277.2 Vac 165.3A, 277.2Vac 166.1A	PV input: 530.0Vdc, 228.9A AC output: 277.1Vac 142.2A, 277.1Vac 143.0A, 277.2Vac 143.2A	PV input: 850.4Vdc, 145.7A AC output: 277.1Vac 145.5A, 277.1Vac 146.0A, 277.2Vac 146.8A	—
Ambient	45.4	45.0	60.0	60.3	—
PV connector	75.6	70.4	73.9	73.8	105
PV lead wires	75.3	68.5	74.4	71.4	105
Hall SN3	78.4	76.7	78.2	78.2	85
PV SPD F3	76.8	73.4	76.1	73.9	90
DC switch	76.0	70.5	78.0	77.7	90
Output lead wires	78.6	77.2	79.3	77.8	105
C14	77.8	74.6	82.1	79.5	90
Input EMI chock L6	94.3	88.3	93.9	92.7	110
Hall SN6	78.1	74.3	81.4	78.9	85
IGBT Q6	87.8	81.8	81.8	79.6	Reference
C15	84.8	79.6	80.8	80.8	90
IGBT2	93.5	92.3	81.0	76.6	125
C10	85.8	83.0	79.8	77.4	90
Relay K2	78.6	73.0	76.4	75.4	110
PCB under R186	91.4	85.0	90.7	90.3	105
Power board transformer TR1	85.6	81.6	92.4	92.1	110
Boost inductor(winding)	82.5	79.5	94.4	89.7	110
Boost inductor(Lead wire)	81.8	79.0	83.9	79.6	105
INV inductor(winding)	95.9	93.8	91.5	89.9	110
INV inductor(Lead wire)	79.4	75.9	80.2	76.7	105
Electrolytic capacitor C3	79.8	75.7	77.6	74.4	105
Cap board Inductor L1	87.2	84.6	80.9	78.9	110
PCB under R4	94.6	89.8	79.0	77.2	105

IEC 62109-1					
Clause	Requirement – Test			Result – Remark	Verdict

Hall J2	75.4	72.8	76.7	75.0	90
C32	76.5	71.2	82.5	77.7	90
PCB under R207	89.4	83.7	80.1	79.7	105
Relay K3	79.8	78.6	74.7	72.7	110
Reactor L1	87.2	86.0	88.3	83.8	110
PCB under Q9	80.6	76.0	87.3	86.3	105
Y cap C40	77.6	74.1	77.4	76.7	90
Transformer TR2(winding)	90.1	86.4	88.9	86.4	110
Transformer TR2(Core)	83.9	79.2	79.1	75.4	130
Transformer TR1(winding)	88.5	82.6	88.5	86.8	110
Transformer TR1(Core)	81.2	74.7	81.0	79.3	130
Power board Inductor L1	84.3	80.9	84.8	80.6	110
SPS Transformer TR1(winding)	85.2	81.4	80.9	76.3	110
Optocoupler PC2	77.2	71.7	73.9	72.7	90
Optocoupler PC3	77.3	72.8	68.8	66.9	90
Inside fan	85.1	82.5	77.9	73.7	90
C16	85.3	81.7	80.7	79.0	90
Output EMI chock L2	100.0	95.9	89.6	87.9	110
Output EMI SPD F2	85.1	80.5	76.4	74.0	90
Output EMI C26	87.7	86.7	75.5	73.1	90
AC output terminal	88.7	87.6	73.5	70.2	90
Enclosure, top	51.4	49.7	63.5	61.5	70
Enclosure, front	49.4	43.6	65.1	64.5	70

TABLE: Heating test, resistance method							N/A	
Temperature rise of winding		R ₁ (Ω)	R ₂ (Ω)	ΔT (K)	Max. dT (K)	Insulation class		
Supplementary information:								
4.4		TABLE: fault condition tests					P	
ambient temperature (°C)				25		—		
No.	component No.	fault	test voltage (V)	test time	fuse No.	fuse current (A)	result	
1.	L1-N	s-c	850	3min	--	--	The PCE does not start up and connected to grid. No damaged, no hazard.	

IEC 62109-1							
Clause	Requirement – Test					Result – Remark	Verdict
2.	L1-L2	s-c	850	3min	--	--	The PCE does not start up and connected to grid. No damaged, no hazard.
3.	AC output (R-S)	Incorrect phase sequence	850	3min	--	--	Operating as normal. No damage. No hazard.
4.	AC output (R-T)	Incorrect phase sequence	850	3min	--	--	Operating as normal. No damage. No hazard.
5.	AC output (S-T)	Incorrect phase sequence	850	3min	--	--	Operating as normal. No damage. No hazard.
6.	AC output	Overload	850	3min	--	--	The PCE operated normally No damaged, no hazard.
7.	Fan	o-s	850	10min	--	--	The inverter temperature rises, then shuts down, reconnect to grid after recovers
8.	MPPT1	Reverse	850	3min	--	--	The PCE can't start. Can resettable. No damage. No hazard.
9.	SN2 (PV board)	s-c	850	3min	--	--	The PCE can't start. Can resettable. No damage. No hazard.
10.	C7 (Capacitor board)	s-c	850	3min	--	--	PV inverter does not start up, IGBT damaged. No hazard.
11.	B-C of IGBT2	s-c	850	3min	--	--	Shut down immediately. IGBT damaged, unable to restart. No hazard.
12.	E-C of IGBT2	s-c	850	3min	--	--	Shut down immediately. IGBT damaged, unable to restart. No hazard.
13.	B-E of IGBT2	s-c	850	3min	--	--	Shut down immediately. IGBT damaged, unable to restart. No hazard.
14.	G-C of Q6 (Boost-Inverter board)	s-c	850	3min	--	--	Shut down immediately. Q6 damaged, unable to restart. No hazard.
15.	E-C of Q6 (Boost-Inverter board)	s-c	850	3min	--	--	Shut down immediately. Q6 damaged, unable to restart. No hazard.
16.	G-E of Q6 (Boost-Inverter board)	s-c	850	3min	--	--	Shut down immediately. Q6 damaged, unable to restart. No hazard.

IEC 62109-1							
Clause	Requirement – Test					Result – Remark	Verdict
17.	G-D of Q2 (AC Sampling board)	s-c	850	3min	--	--	The PCE can't start. Can resettable. No damage. No hazard.
18.	G-S of Q2 (AC Sampling board)	s-c	850	3min	--	--	The PCE can't start. Can resettable. No damage. No hazard.
19.	D-S of Q2 (AC Sampling board)	s-c	850	3min	--	--	The PCE can't start. Can resettable. No damage. No hazard.
20.	TR2 (Pin 1-6)(Power board)	s-c	850	3min	--	--	The PCE can't start. Can resettable. No damage. No hazard.
21.	D-S of Q10 (Power board)	s-c	850	3min	--	--	The PCE can't start. Can resettable. No damage. No hazard.
22.	TR1 (Pin 7-8) (Power board)	s-c	850	3min	--	--	The PCE can't start. Can resettable. No damage. No hazard.
23.	TR1 (Pin 11-12) (Power board)	s-c	850	3min	--	--	The PCE can't start. Can resettable. No damage. No hazard.
24.	D-S of Q11 (Power board)	s-c	850	3min	--	--	The PCE can't start. Can resettable. No damage. No hazard.
25.	RT1 (Pin 2-3) (Drive board)	s-c	850	3min	--	--	The PCE can't start. Can resettable. No damage. No hazard.
26.	PC1 (Pin 4-5) (Drive board)	s-c	850	3min	--	--	The PCE can't start. Can resettable. No damage. No hazard.
27.	U1 (Pin12-13) (AC Sampling board)	s-c	850	3min	--	--	The PCE can't start. Can resettable. No damage. No hazard. Error message:10-02
28.	SN4 (Pin2-4) (AC Sampling board)	s-c	850	3min	--	--	The PCE can't start. Can resettable. No damage. No hazard. Error message:43-01
29.	C16 (AC Sampling board)	s-c	850	3min	--	--	The PCE can't start. Can resettable. No damage. No hazard. Error message:10-01
30.	C15 (AC Sampling board)	s-c	850	3min	--	--	The PCE can't start. Can resettable. No damage. No hazard. Error message:43-01

IEC 62109-1							
Clause	Requirement – Test					Result – Remark	Verdict

31.	Relay K1 (L1 phase)	s-c before start up	850	3min	--	--	The PEC can't connect to grid. Can resettable. No damage. No hazard. Error message:11-02
32.	Relay K3 (L2 phase)	s-c before start up	850	3min	--	--	The PEC can't connect to grid. Can resettable. No damage. No hazard. Error message:11-02
33.	Relay K5 (L3 phase)	s-c before start up	850	3min	--	--	The PEC can't connect to grid. Can resettable. No damage. No hazard. Error message:11-02
34.	G-D of Q2 (AC Sampling board)	s-c before start up	850	3min	--	--	The PCE can't start. Can resettable. No damage. No hazard. Error message:11-02
35.	G-S of Q2 (AC Sampling board)	s-c before start up	850	3min	--	--	The PCE can't start. Can resettable. No damage. No hazard. Error message:11-02
36.	D-S of Q2 (AC Sampling board)	s-c before start up	850	3min	--	--	The PCE can't start. Can resettable. No damage. No hazard. Error message:11-02
37.	R333 (AC Sampling board)	o-c before start up	850	3min	--	--	Operating as normal. No damage. No hazard.
38.	TR1(ARM board)	s-c before start up	850	3min	--	--	The PCE can't start. Can resettable. No damage. No hazard.
39.	PC3(ARM board)	s-c before start up	850	3min	--	--	The PCE can't start. Can resettable. No damage. No hazard.
40.	SN2 (PV board)	s-c before start up	850	3min	--	--	The PCE can't start. Can resettable. No damage. No hazard. Error message:01-01
41.	TR1 (PIN2-3) (driver board)	s-c before start up	850	3min	--	--	The PCE can't start. Can resettable. No damage. No hazard.

supplementary information:

s-c: short-circuited, o-c: open-circuited, o-l: overload.

During the test:

Fire do not propagate beyond the PCE;

Equipment do not emit molten metal;

Enclosures do not deform to cause non-compliance with the standard.

Pass the dielectric test.

IEC 62109-1			
Clause	Requirement – Test	Result – Remark	Verdict

7.3.6.3.3	TABLE: protective equipotential bonding;				N/A
Measured between:	Test current (A)	Voltage drop (V)	Resistance (mΩ)	result	
Earthing terminal and furthest heatsink side	--	--	--	--	
supplementary information The alternative of 7.3.6.3.5 was considered.					

7.3.6.3.7	TABLE: touch current measurement			P
Measured between:	Measured (mA)	Limit (mA)	Comments/conditions	
Earthing terminal and metal enclosure	7.2	3.5	N/A	
supplementary information The touch current measured has exceed. So provision of an additional terminal for a second protective earthing conductor is necessary and installation instructions stated a second protective earthing conductor shall be installed. In addition, the caution symbol 15 of Annex C is fixed to the product and and the installation manual had provided details of the protective earthing measures required in the installation as required in 5.3.2.				

7.3.7	TABLE: clearance and creepage distance measurements						P
clearance cl and creepage distance dcr at / of:	Up (V)	U r.m.s. (V)	required cl (mm)	cl (mm)	required dcr (mm)	dcr (mm)	
PV board circuits to metal enclosure (BI)	1100Vdc	1100V 314	4.5	6.2	5.5	6.2	
DC EMI board circuits to metal enclosure (BI)	1100Vdc	1100V 314	4.5	6.1	5.5	6.1	
Inverter board circuits to metal enclosure (BI)	1100Vdc	1100V 314	4.5	6.5	5.5	6.5	
Capacitor board circuits to metal enclosure (BI)	1100Vdc	1100V 314	4.5	7.2	5.5	7.2	
Boost board circuits to metal enclosure (BI)	1100Vdc	1100V 314	4.5	6.3	5.5	6.3	
Power board circuits to metal enclosure (BI)	1100Vdc	1100V 314	4.5	6.2	5.5	6.2	
Power board circuits to secondary circuits (RI)	1100Vdc	1100V 314	7.8	16.0	11	16.0	
Control board circuits to metal enclosure (BI)	1100Vdc	1100V 314	7.8	16.0	11	16.0	
AC EMI board circuits to metal enclosure (BI)	1100Vdc	1100V 314	4.5	6.2	5.5	6.2	

IEC 62109-1			
Clause	Requirement – Test	Result – Remark	Verdict

7.3.7	TABLE: clearance and creepage distance measurements		P
<p>Remarks:</p> <p>1) FI: function insulation BI: Basic insulation SI: Supplementary insulation RI: Reinforced insulation 2) A force of 10 N applied to the internal components and 250 N applied to the enclosure for measure 3) For PV circuit, system voltage is 1100V and overvoltage Category is OVCII, impulse voltage corresponding to PV circuit is 4772V. 4)For AC main circuit, nominal voltage is 311V and overvoltage category is OVC III, impulse voltage is corresponding to main circuit is 4100V. 5)For relay across main output . RMS voltage used for creepage is rationalized to 600V and overvoltage category is OVCII. For other insulation between live parts, which PV circuit and main circuit is not isolated PV system voltage 1100V is considered for the maximum working voltage. 6)The PCE enclosure is rated IP65 and the pollution degree inside enclosure is reduced from PD3 to PD2. 7)The disconnection devices are two relay in series at line. Clearance between contacts of each relay rated min. 1.5mm. each relay with two contact gaps together to withstand the PV impulse voltage according to IEC 62109-2 Clause 4.4.4.15.2.2. Thus the clearance requirement for each contact is half of the requirement. 8) Have been corrected accord to altitude up to 4000m 9)Triple Insulated Wire is used on transformer TR1 as secondary output.</p>			

7.3.7	TABLE: distance through insulation measurement			P
distance through insulation di at/of:	U r.m.s. (V)	test voltage (V)	required di (mm)	di (mm)
Optocoupler	314Vac 1100Vdc	4240Vdc	--	certified
Insulation sheet	314Vac 1100Vdc	2120Vdc	--	0.26

7.5	TABLE: electric strength measurements, impulse voltage test and partial discharge test			P
test voltage applied between:	test voltage (V)	impulse withstand voltage (V)	partial discharge extinction voltage (V)	result
DC input terminal to earthed enclosure	2120Vdc	4772	N/A	No breakdown
AC Output terminal to earthed enclosure	2120Vdc	6460	N/A	No breakdown
AC Output terminal to communication port	4240Vdc	6460	N/A	No breakdown
DC input terminal to communication port	4240Vdc	6460	N/A	No breakdown
Insulation sheet	2120Vdc	4772	N/A	No breakdown
One layer of insulation tape	4240Vdc	6460	N/A	No breakdown
Relay pin 3 to pin 4	2120Vdc	4772	N/A	No breakdown

IEC 62109-1			
Clause	Requirement – Test	Result – Remark	Verdict

9.2	TABLE: Limited power sources		N/A
-----	-------------------------------------	--	-----

Circuit output tested:

Note: Measured Uoc (V) with all load circuits disconnected:

Components	Sample No.	Uoc (V)	I _{sc} (A)		VA	
			Meas.	Limit	Meas.	Limit

supplementary information:

Sc=Short circuit, Oc=Open circuit

IEC 62109-1			
Clause	Requirement – Test	Result – Remark	Verdict

14	TABLE: list of critical components					P
object/part No.	manufacturer/ trademark	type/model	technical data	standard	mark(s) of conformity ¹⁾	
The whole unit						
Metal enclosure	Interchangeable	Interchangeable	Galvanized steel plate, outdoor powder dust, 1050x660x330(mm) , Min.thickness 1.0mm	IEC/EN 62109-1 IEC/EN 62109-2	Tested with appliance	
PV lead wiring	3Q Wire & Cable Co.,Ltd.	10269	10AWG, 105°C	UL758	E341104	
PCB	Various	KB-6160C	V-0,130°C	UL 796	UL E123995	
PV input terminal	Dongguan Vaconn Electronic Technology Co.,Ltd.	VP-D4B-PHSM4B	1100Vd.c,35A, 85°C	EN62854	TUV RH R 50492180	
(Alternative)	Dongguan Vaconn Electronic Technology Co.,Ltd.	VP-D4B-PHSF4B	1100Vd.c,35A, 85°C	EN62854	TUV RH R 50492180	
AC output terminal	SHENZHEN CONNECTION ELECTRONIC CO LTD	DRTB100-R	1000V,300A	UL 1059	UL E304128	
DC switch	Zhejiang Benyi Electrical Co., Ltd.	BYSS.1-32/T-6P, BYSS.1-32/T-8P	40A/800V 32A/1000V 25A/1200V	EN 60947-3	TUV R 50425301	
(Alternative)	ProJoy Electric Co., Ltd.	PEDS150R-HM55-6, PEDS150R-HM55-8	45A/800V 25A/1000V 15A/1200V	EN 60947-3	TUV R 50494197	
Boost inductor	BoLuo DaXin Electronics Co., Ltd.	DG1726-DX2846	Class B	IEC/EN 62109-1 IEC/EN 62109-2	Tested with appliance	
Inv inductor	Qingdao Yunlu Juneng	PE2006	Class H	IEC/EN 62109-1	Tested with	

IEC 62109-1			
Clause	Requirement – Test	Result – Remark	Verdict

14	TABLE: list of critical components					P
object/part No.	manufacturer/ trademark	type/model	technical data	standard	mark(s) of conformity ¹⁾	
	Electrical Co., Ltd.			IEC/EN 62109-2	appliance	
Inside Fan	NMB Technologies Corporation	12038VA-24Q- FU	24V, 1.04A, 5700rpm	UL 507	UL E89936	
(Alternative)	CROWN	AGD12038B24 M	24Vdc,1.45A, 5200RPM	UL 507	UL E516545	
Outside Fan	NMB Technologies Corporation	09238DE-24P- CU01	24V, 1.1A, 10000rpm	IEC/EN 60950-1	VDE 1507300	
(Alternative)	CROWN	AGB09238B24V	24V, 1.7A, 8000rpm	UL 507	UL E516545	
Comm board						
Communication Optocoupler PC1	Texas Instruments	ISO7841FDWW R	125°C, 5700Vrms, clearance: 14.5mm, Creepage distance: 14.5mm	EN 60950-1 EN 61010-1 EN 62368-1	TÜV SÜD U8V 077311 0018 rev.01	
Communication Optocoupler PC2	Texas Instruments	ISO7842FDWW R	125°C, 5700Vrms, clearance: 14.5mm, Creepage distance: 14.5mm	EN 60950-1 EN 61010-1 EN 62368-1	TÜV SÜD U8V 077311 0018 rev.01	
MCU U12	ST	STM32F107VC T6	100 PIN, 105°C, SMD	IEC/EN 62109-1 IEC/EN 62109-2	Tested with appliance	
PV board						
Input Y Cap C1, C2, C3, C4, C5, C6, C7, C8, C9, C10, C11, C12, C13, C14, C15, C16, C17, C18, C19, C20	XIAMEN FARATRONIC CO., LTD.	MKP63Q1102M 40C450	0.001uF/300Vac , 110°C	IEC/EN 60384- 14	SE/0366-2B	
Input Y Cap C21, C22, C23, C24, C25, C26, C27, C28, C29, C30, C31, C32, C33, C34, C35, C36, C37, C38,	XIAMEN FARATRONIC CO., LTD.	MKP63Q1103M 40C400	0.01uF/300Vac, 110°C	IEC/EN 60384- 14	SE/0366-2B	

IEC 62109-1			
Clause	Requirement – Test	Result – Remark	Verdict

14	TABLE: list of critical components					P
object/part No.	manufacturer/ trademark	type/model	technical data	standard	mark(s) of conformity ¹⁾	
C39, C40						
Hall SN1, SN2, SN3, SN4, SN5, SN6, SN7, SN8, SN9, SN10	SINOMAGS TECHNOLOGY CO., LTD.	STK-CTS/P	5V,25A, 105°C	UL 508	E 507664	
DC SPD F1, F2, F3, F4, F5, F6, F7, F8, F9, F10, F11, F12, F13, F14	SET	TFMOV10M510	510Vd.c,10KA, 85°C	EN 61643-11	TUV RH R50438698	
Power board						
Transformer (TR2)	BoLuo DaXin Electronics Co., Ltd.	KB1726-27362	Class B	IEC 62109-1 IEC 62109-2	Tested with appliance	
- BOBBIN	CHANG CHUN PLASTICS CO.,LTD	T375HF	V-0, 150°C	IEC 62109-1 IEC 62109-2	E59481 Tested with appliance	
- COPPER WIRE	HUIZHOU GOLDEN OCEAN MAGNET WIRE FACTORY	xUEW-F	155°C	IEC 62109-1 IEC 62109-2	E225143 Tested with appliance	
(Alternative)	HOI LUEN ELECTRICAL MFR CO.,LTD	xUEW-F	155°C	IEC 62109-1 IEC 62109-2	E164409 Tested with appliance	
- TAPE	JINGJIANG YAHUA PRESSURE SENSITIVE GLUE CO LTD	CT	130°C	IEC 62109-1 IEC 62109-2	E165111 Tested with appliance	
-MARGIN TAPE	JINGJIANG YAHUA PRESSURE SENSITIVE GLUE CO LTD	WF	130°C	IEC 62109-1 IEC 62109-2	E165111 Tested with appliance	
- EPOXY	DONGGUAN EATTO ELECTRONIC MATERIAL CO LTD	E-500(xx)	V-0, 130°C	IEC 62109-1 IEC 62109-2	E218090 Tested with appliance	
Transformer (TR1)	BoLuo DaXin Electronics Co., Ltd.	KB1726-27361	Class B	IEC 62109-1 IEC 62109-2	Tested with appliance	

IEC 62109-1			
Clause	Requirement – Test	Result – Remark	Verdict

14	TABLE: list of critical components					P
object/part No.	manufacturer/ trademark	type/model	technical data	standard	mark(s) of conformity ¹⁾	
- BOBBIN	CHANG CHUN PLASTICS CO.,LTD	T375HF	V-0, 150°C	IEC 62109-1 IEC 62109-2	E59481 Tested with appliance	
- COPPER WIRE	HUIZHOU GOLDEN OCEAN MAGNET WIRE FACTORY	XUEW-F	155°C	IEC 62109-1 IEC 62109-2	E225143 Tested with appliance	
(Alternative)	HOI LUEN ELECTRICAL MFR CO.,LTD	XUEW-F	155°C	IEC 62109-1 IEC 62109-2	E164409 Tested with appliance	
- TAPE	JINGJIANG YAHUA PRESSURE SENSITIVE GLUE CO LTD	CT	130°C	IEC 62109-1 IEC 62109-2	E165111 Tested with appliance	
-MARGIN TAPE	JINGJIANG YAHUA PRESSURE SENSITIVE GLUE CO LTD	WF	130°C	IEC 62109-1 IEC 62109-2	E165111 Tested with appliance	
- EPOXY Dark glue	DONGGUAN EATTO ELECTRONIC MATERIAL CO LTD	E-500(xx)	V-0, 130°C	IEC 62109-1 IEC 62109-2	E218090 Tested with appliance	
Optocoupler PC6, PC10, PC11	RENESAS ELECTRONICS CORPORATIO N	PS2561L1-1	Cl>7mm, voltage:5000V	EN 60747	VDE 40008862	
Optocoupler U14, U15, U16, U17, U18, U19	Texas Instruments Deutschland GmbH	UCC23513DWY R	Cr:>8.5mm,Cl:> 8.5mm, voltage:5000V	IEC 62109-1 IEC 62109-2	VDE 40040142	
MOS Q9, Q10	ST	STFW3N150	2.5A,1500V, 150°C	IEC 62109-1 IEC 62109-2	Tested with appliance	
MOS Q11	CREE	C2M1000170D	3.5A,1700V, 150°C	IEC 62109-1 IEC 62109-2	Tested with appliance	
Y Cap C34, C35, C36, C37, C40, C41	TDK CORPORATIO N	CD series	0.0047Uf,440Va c, 105°C	IEC 348-14	VDE 40029780	
Film Cap C1,C2,C3,C4,C	XIAMEN FARATRONIC	C3D series	50uF,600Vac, 105°C	IEC 62109-1	Tested with	

IEC 62109-1			
Clause	Requirement – Test	Result – Remark	Verdict

14	TABLE: list of critical components					P
object/part No.	manufacturer/ trademark	type/model	technical data	standard	mark(s) of conformity ¹⁾	
5,C6,C7,C8,C9, C10,C11,C12	CO., LTD.			IEC 62109-2	appliance	
Input X cap C13,C14,C16,C 17,C62	XIAMEN FARATRONIC CO., LTD.	C3D series	10uF,1100Vdc, 105°C	IEC/EN 61071:2007	TUV R 50266108	
Boost IGBT Q1,Q2,Q3,Q4,Q 7,Q8,Q9,Q10,Q 11,Q12	infineon	IKY40N120CH3	1200V,40A, 175°C	IEC 62109-1 IEC 62109-2	Tested with appliance	
(Alternative)	ONSEMI	FGH40T120SQ DNL4	1200V,40A, 175°C	IEC 62109-1 IEC 62109-2	Tested with appliance	
INV IGBT IGBT1,IGBT2,I GBT3	ONSEMI	NXH450N65L4 Q2F2SG	650V,450A, 150°C	IEC 62109-1 IEC 62109-2	E468801 Tested with appliance	
(Alternative)	infineon	F3L400R07W3 S5	650V,400A, 150°C	IEC 62109-1 IEC 62109-2	E83335 Tested with appliance	
(Alternative)	Vincotech Hungaria Kft.	30- FT07NIB300S5 03-LH36F58	650V,260A, 175°C	IEC 62109-1 IEC 62109-2	E192116 Tested with appliance	
Diode D1,D2,D3,D4,D 7,D8,D9,D10,D1 1,D12	Fairchild	APT60DQ120B G	1200V,60A, 175°C	IEC 62109-1 IEC 62109-2	Tested with appliance	
Control board						
DSP U57, U58	Texas Instruments	TMS320F28377	85°C	IEC 62109-1 IEC 62109-2	Tested with appliance	
CPLD U42	ALTERA	EPM240T100C 5N	85°C	IEC 62109-1 IEC 62109-2	Tested with appliance	
(Alternative)	Gowin Semiconductor Corporation	LQ100X	85°C	IEC 62109-1 IEC 62109-2	Tested with appliance	
MCU U15,U16,U17,U 18,U26,U27	Texas Instruments	SN74ACT244	85°C	IEC 62109-1 IEC 62109-2	Tested with appliance	
Other parts						
Relays K1,K2,K3,K4,K5 ,K6	Dongguan Churod ElectronicsCo., Ltd.	CHAR-112A200	200A, 830VAC, 85°C	EN 61810- 1:2008	TUV R50316974	
Input X Cap C2,C4,C6,C8,C	XIAMEN FARATRONIC	C3D series	10µF/1100Vac, 105°C	IEC/EN 61071:2007	TUV R 50266108	

IEC 62109-1			
Clause	Requirement – Test	Result – Remark	Verdict

14	TABLE: list of critical components					P
object/part No.	manufacturer/ trademark	type/model	technical data	standard	mark(s) of conformity ¹⁾	
14,C16,C18,C20,C22,C24	CO., LTD.					
EMI Hall SN1,SN2,SN3,SN4,SN5,SN6,SN7,SN8,SN9,SN10	SINOMAGS TECHNOLOGY CO., LTD.	STK-PL	5V,32A, 105°C	UL 508	E 507664	
(Alternative)	LEM	HLSR 32-P	5V, 32A, 105°C	ANSI/UL 508	UL E189713	
Electrolytic capacitors C1, C2, C3, C4, C5, C6, C7, C8, C9, C10, C11, C12, C13, C14, C15, C16, C17, C18	Nantong Jianghai Capacitor Co., Ltd	ECS2YBB471M LA350060E	550Vdc, 470uF, 105°C	IEC 62109-1 IEC 62109-2	Tested with appliance	
(Alternative)	RUBYCON	550MXG470MS GPSN	550Vdc, 470uF, 105°C	IEC 62109-1 IEC 62109-2	Tested with appliance	
(Alternative)	CapXon	UK471M550P60 0A	550Vdc, 470uF, 105°C	IEC 62109-1 IEC 62109-2	Tested with appliance	
Inductor L1, L2	BoLuo DaXin Electronics Co., Ltd.	LC36-142	5uH, 1*5mm, 14.5Ts, Class B	IEC 62109-1 IEC 62109-2	Tested with appliance	
Driver board transformer TR1	BoLuo DaXin Electronics Co., Ltd.	HX1726	Class B	IEC 62109-1 IEC 62109-2	Tested with appliance	
Driver board Optocoupler PC1, PC2	Texas Instruments	UCC23513DWY R	Cr:>8.5mm,Cl:> 8.5mm, voltage:5000V	IEC 62109-1 IEC 62109-2	Tested with appliance	
DM inductor L1	Qingdao Yunlu Juneng Electrical Co., Ltd.	PE2007	Class E	IEC 62109-1 IEC 62109-2	Tested with appliance	
Hall SN4	LEM International SA	CTSR 1-TP/SP 18	1000Vac/dc, 150A, 105°C	ANSI/UL61010- 1 ANSI/UL61010- 2-201	UL E189713	
(Alternative)	SINOMAGS TECHNOLOGY CO., LTD.	SFG-P	1000Vac/dc, 150A, 105°C	ANSI/UL61010- 1 ANSI/UL61010- 2-201	UL E507664	

IEC 62109-1			
Clause	Requirement – Test	Result – Remark	Verdict

14	TABLE: list of critical components					P
object/part No.	manufacturer/ trademark	type/model	technical data	standard	mark(s) of conformity ¹⁾	
Hall SN1, SN2, SN3	LEM International SA	LZSR200-PS P1	200A, 5V, 85°C	ANSI/UL 61010- 1 ANSI/UL61010- 2-201	UL E189713	
(Alternative)	SINOMAGS TECHNOLOGY CO., LTD.	STB-LA/ZN	200A, 5V, 105°C	ANSI/UL 61010- 1 ANSI/UL61010- 2-201	UL E507664	
Electrolytic capacitors C27, C28, C29, C31, C32, C33, C35, C36, C37	XIAMEN FARATRONIC CO., LTD.	C6A series	8uF, 380Vac, 105°C	ANSI/UL 810	UL E256238	
Common Choke L2	Qingdao Yunlu Juneng Electrical Co., Ltd.	PE2008	Class B	IEC 62109-1 IEC 62109-2	Tested with appliance	
Y Cap C7, C8, C9, C11, C12, C13, C14	SHANXI HUAXING ELECTRONIC DEVELOPMENT CO	CT7Y1 Series	0.0047uF, 400Vac, Y1, 125°C	IEC/EN 60348- 14	VDE 40015542	
Y Cap C15, C16, C17, C21, C22, C23	TDK CORPORATIO N	CD series	0.0022uF, 400Vac, Y1, 85°C	IEC 60384-14	VDE 40029780	
Electrolytic capacitors C15, C16, C17, C21, C22, C23	XIAMEN FARATRONIC CO., LTD.	C4B series	2.2uF, 400Vac, 125°C	ANSI/UL 60384-14	UL E186600	
SPD F1, F2, F3	Xiamen Set Electronics Co., Ltd.	TMOV34Sxxx	670Vd.c., 20kA, 85°C	EN 61643-11	TÜV J50226017	
1)						

Appendix 1: Photos



Front view

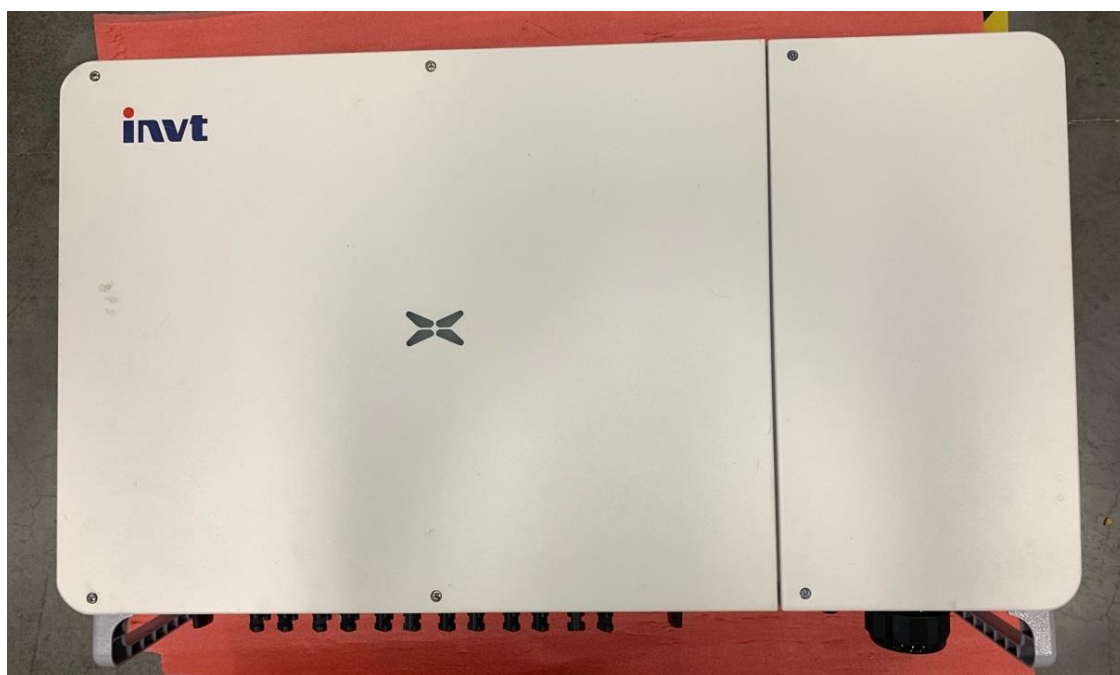

Front view



Side view



Connection view (for 9 strings)



Connection view (for 10 strings)



Connection view (for 12 strings)



Internal view

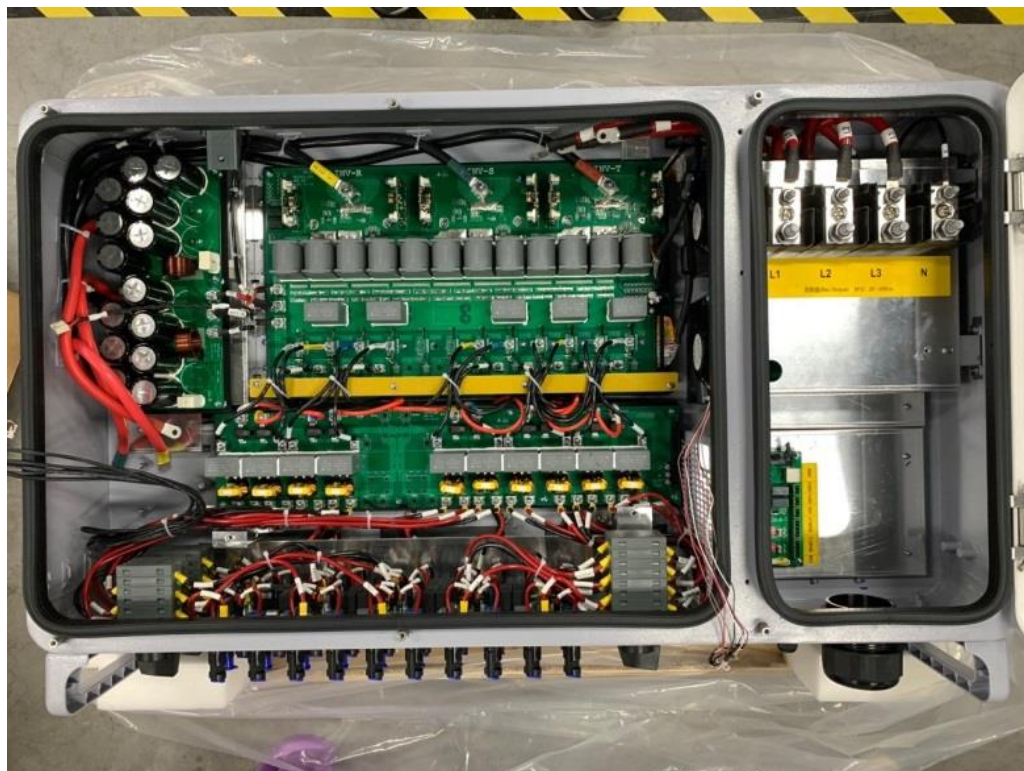

Internal view

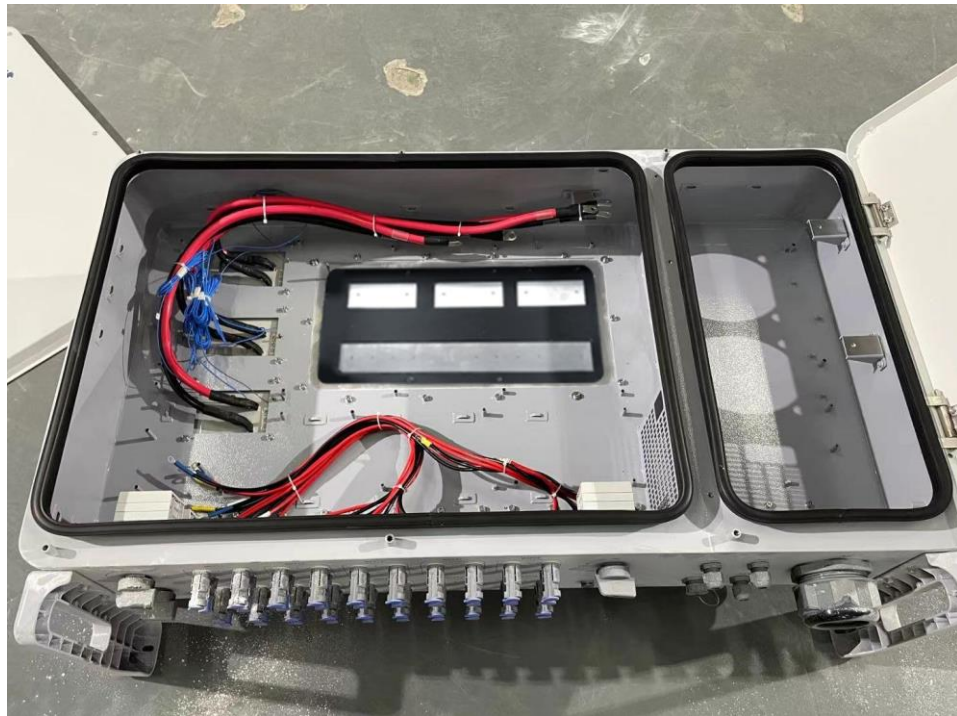

Internal view

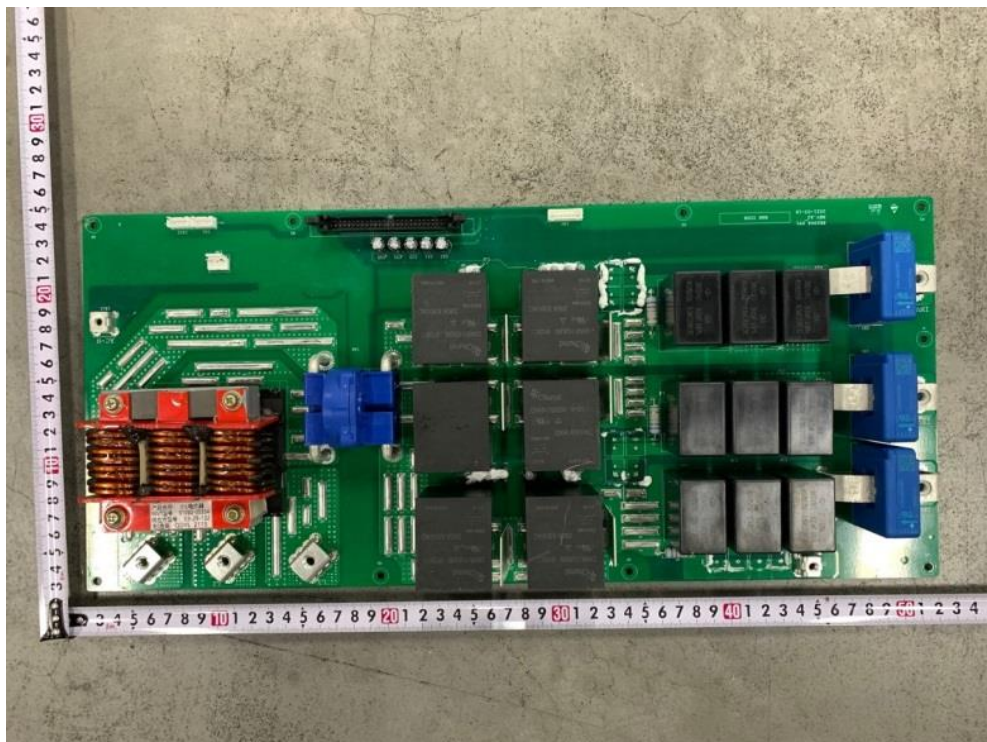

AC Sampling board view

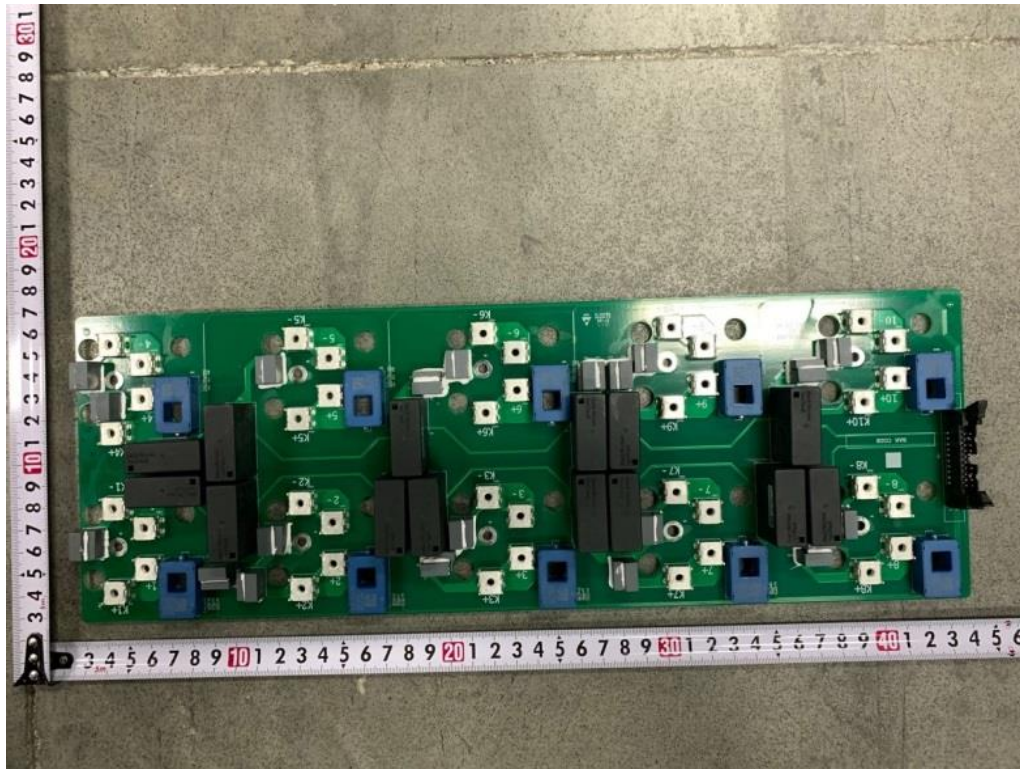

PV input board view (Components side, for 9 and 10 strings)

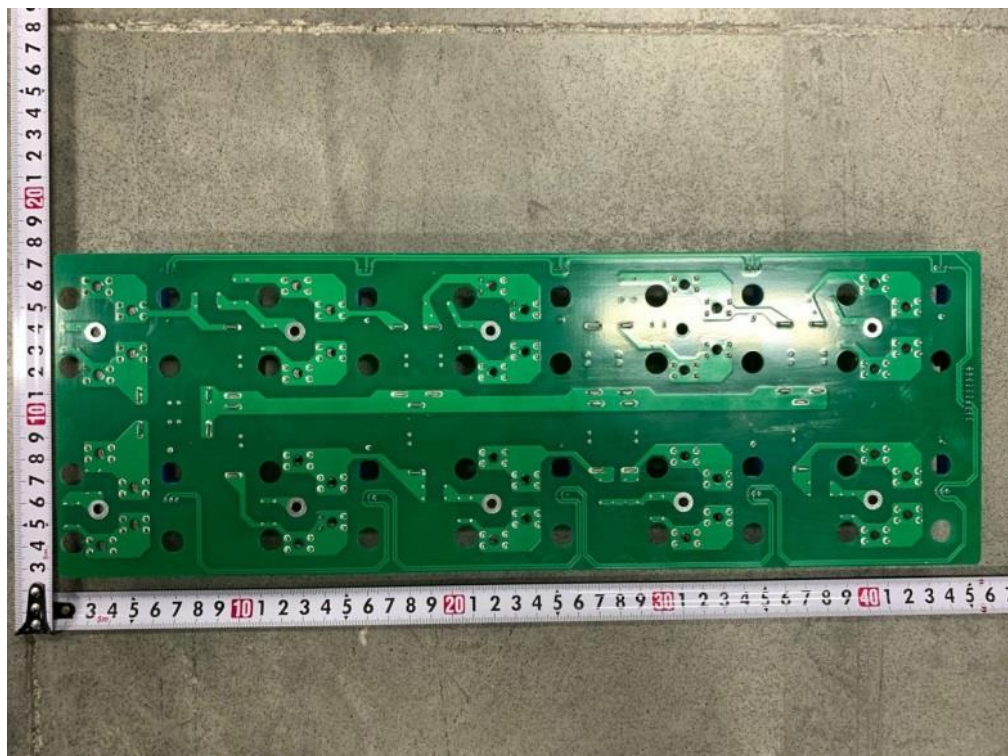

PV input board view view (Soldered side, for 9 and 10 strings)

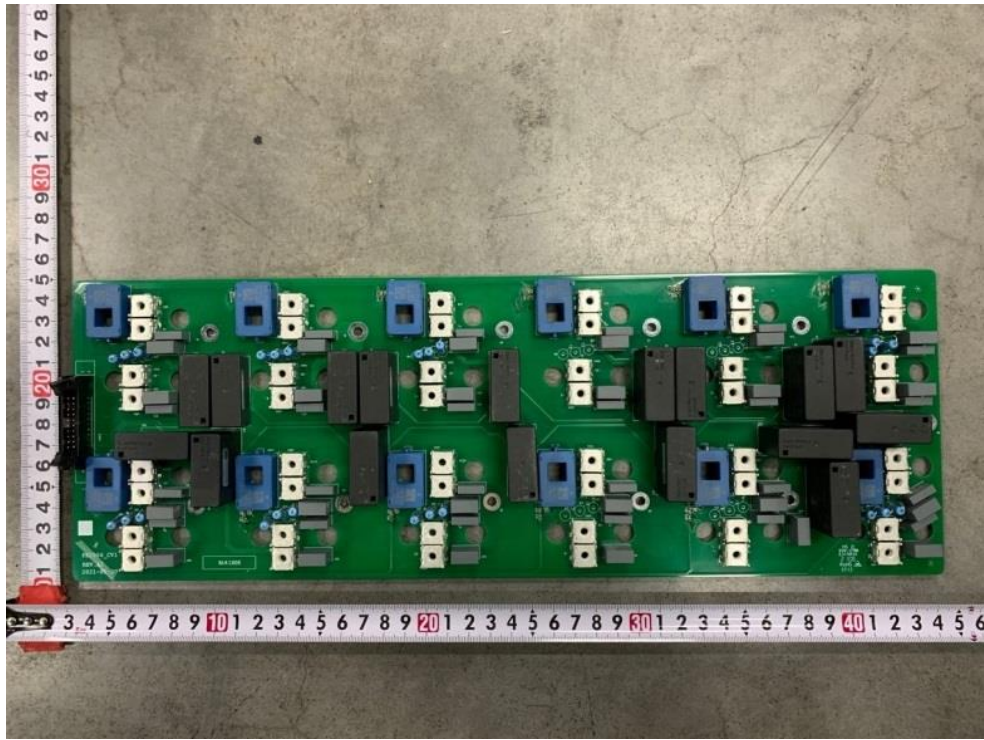

PV input board view (Components side, for 12 strings)

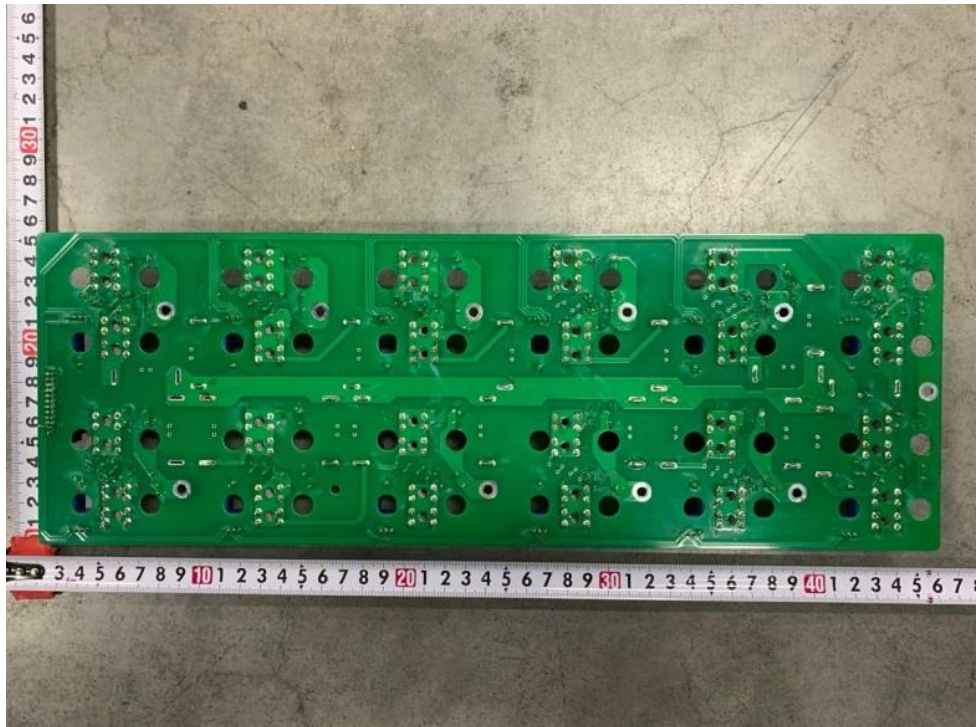

PV input board view (Soldered side, for 12 strings)



DC EMI board view(Components side)

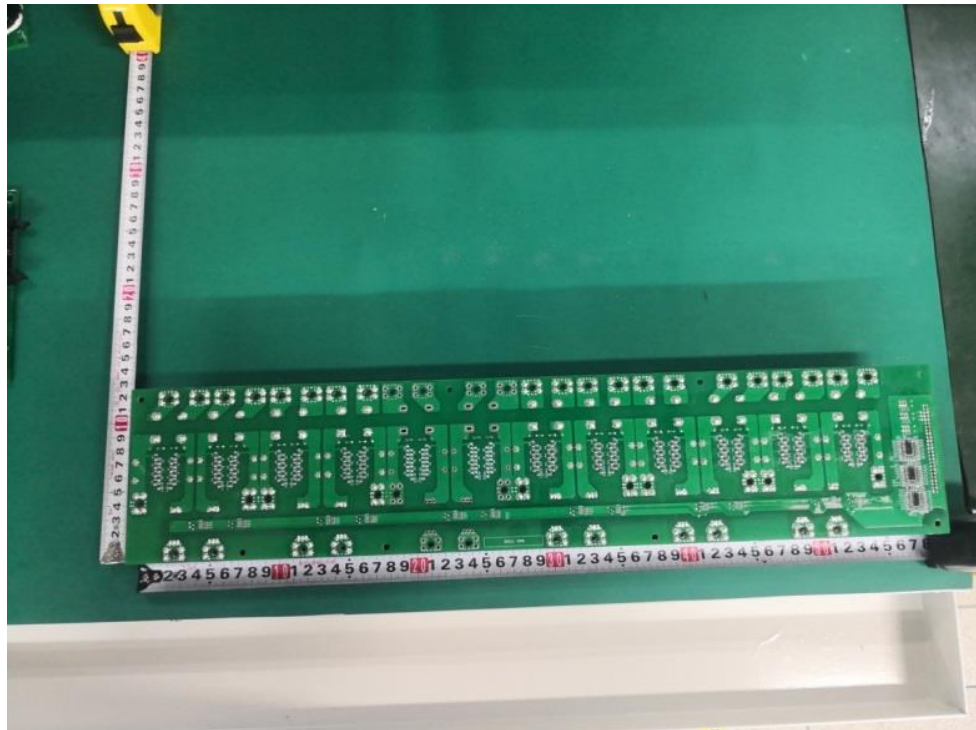

DC EMI board view(Soldered side)



Capacitor board(Components side)

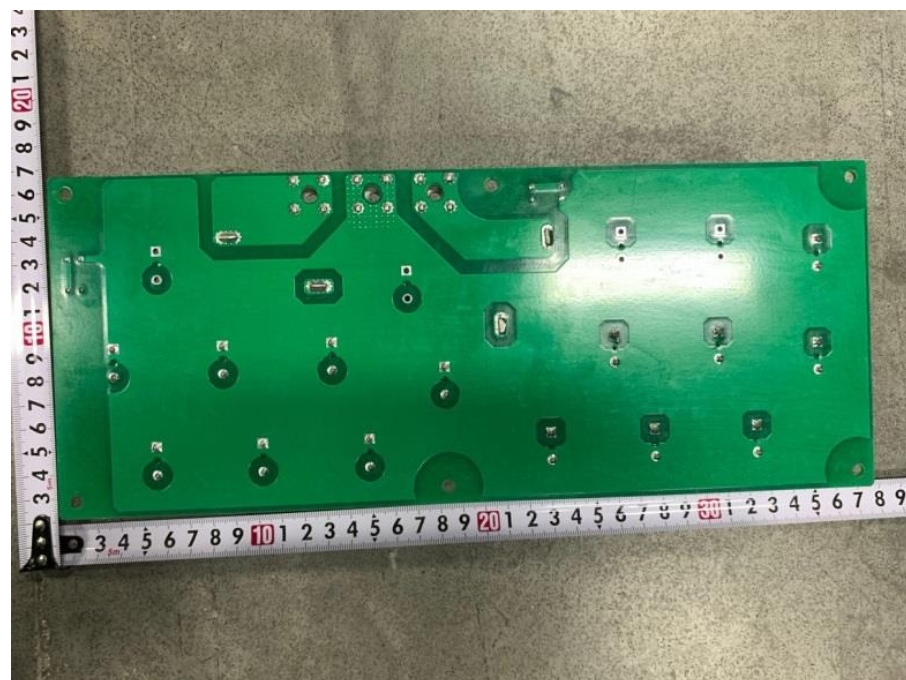

Capacitor board(Soldered side)

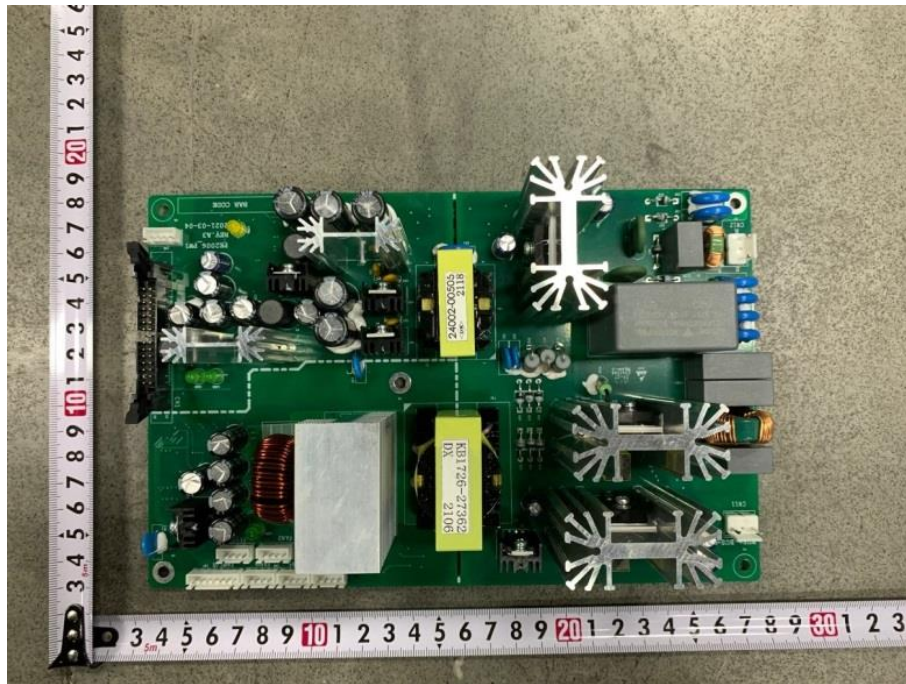

Power board view (Components side)

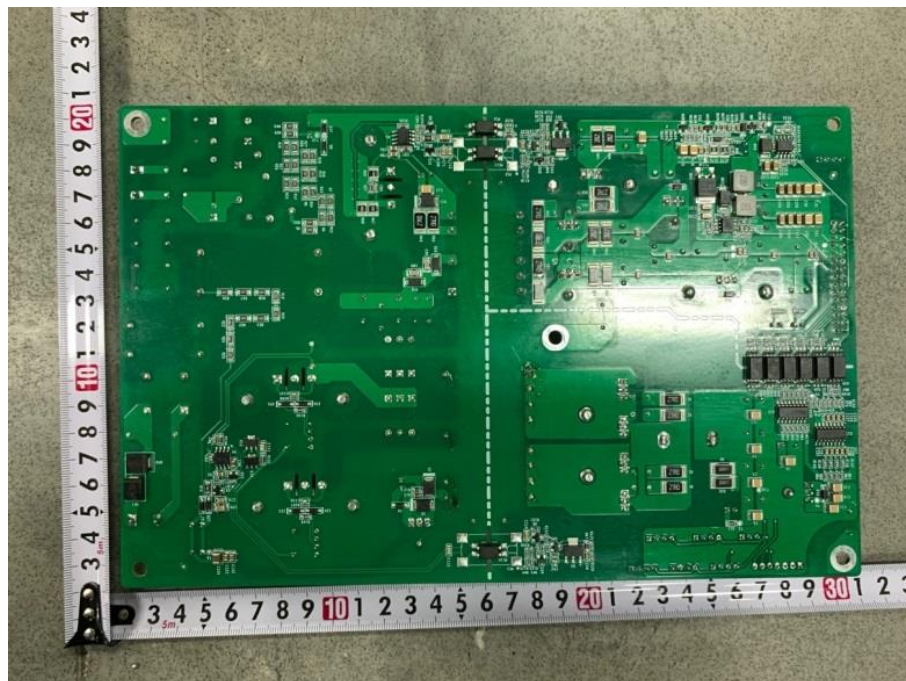

Power board view (Soldered side)

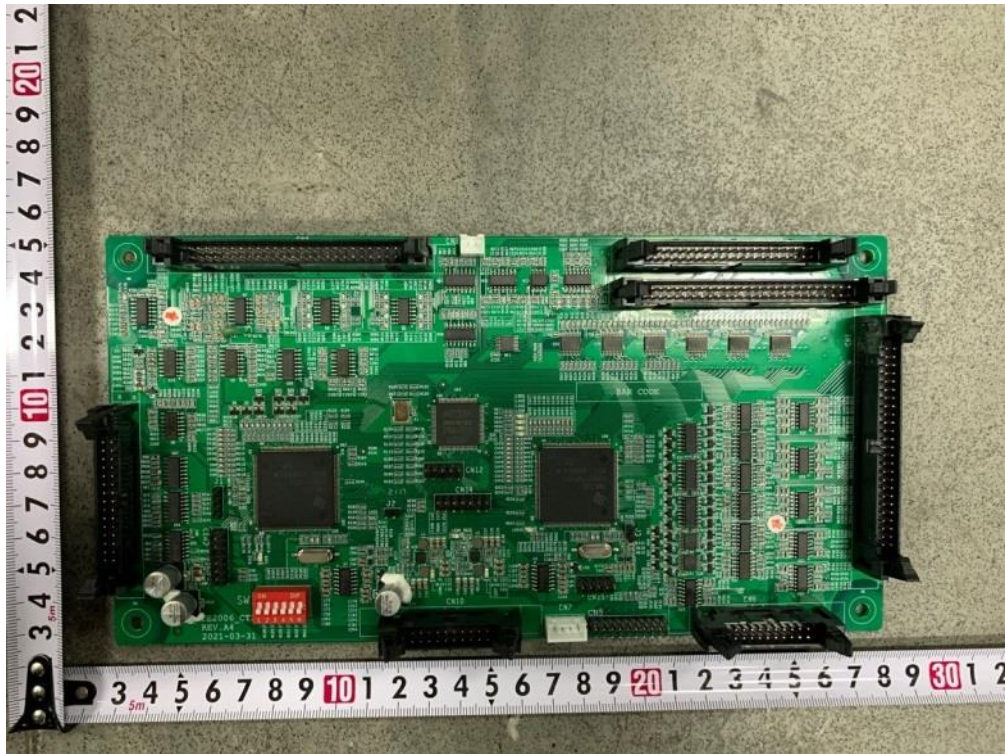

Control board view (Components side)

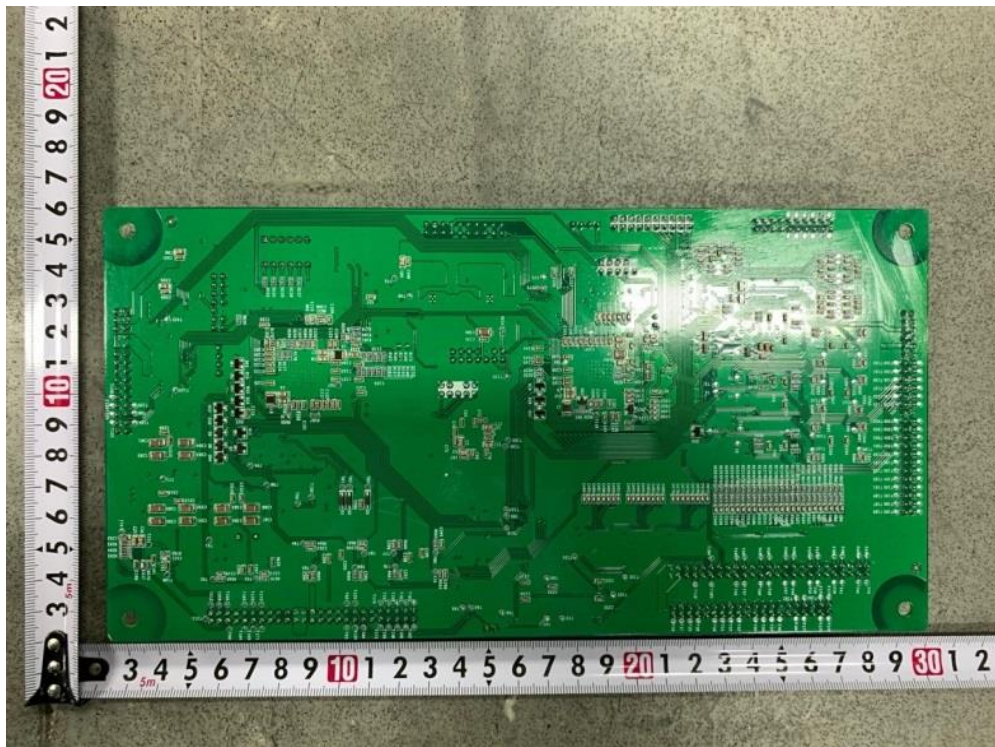

Control board view (Reverse)

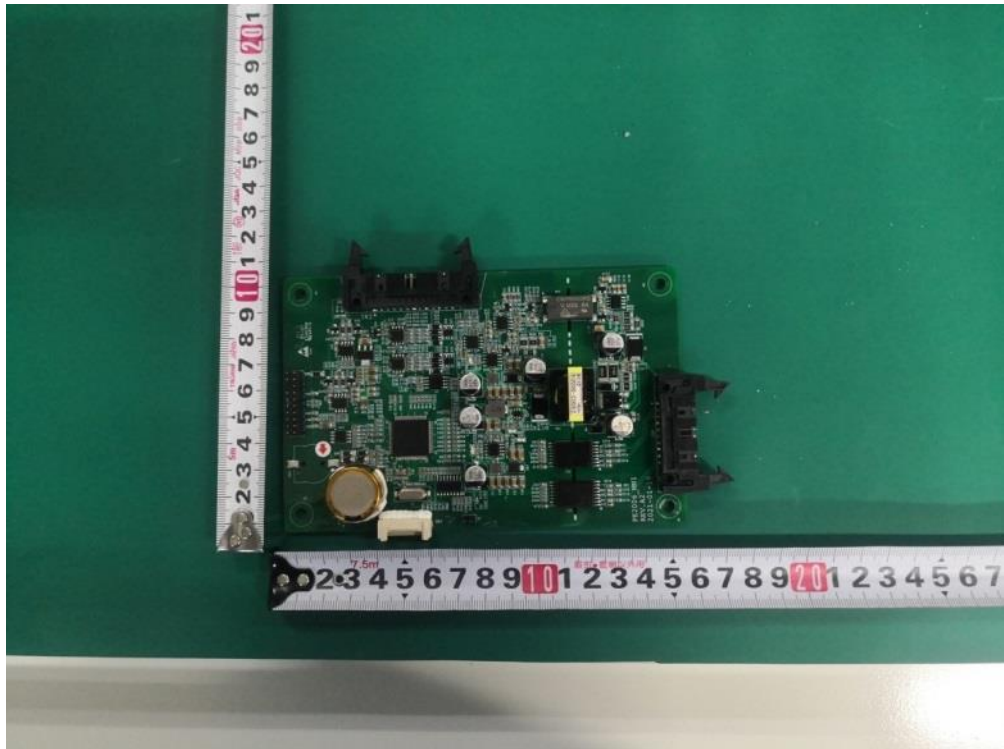

ARM board view

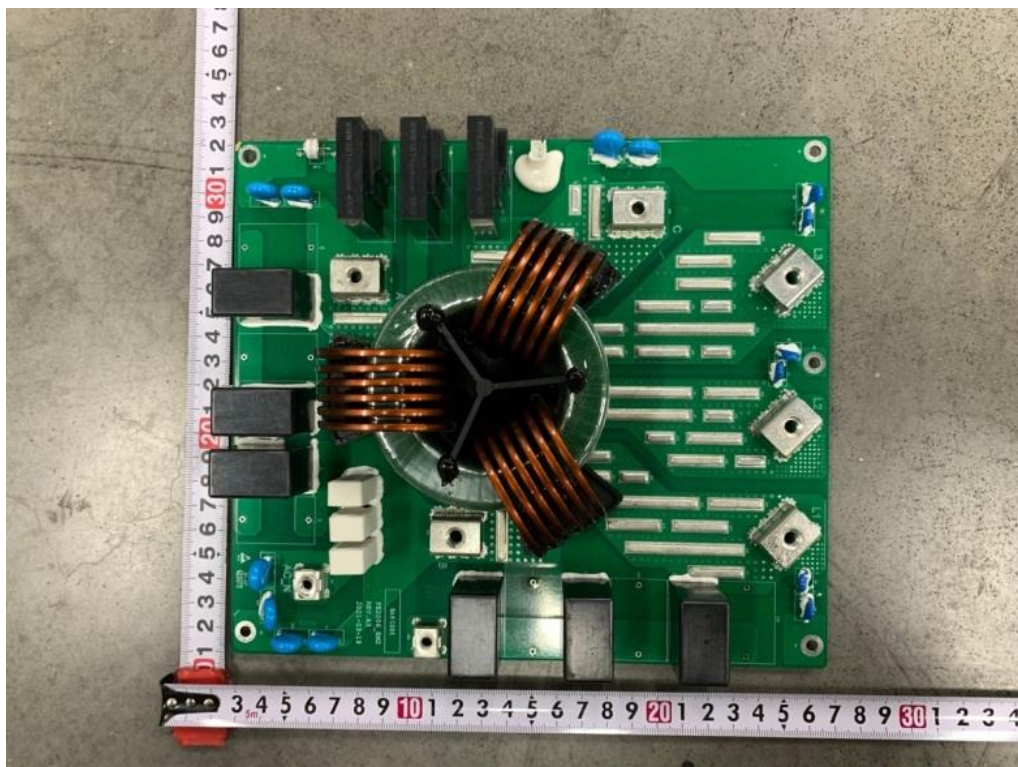

AC EMI board view

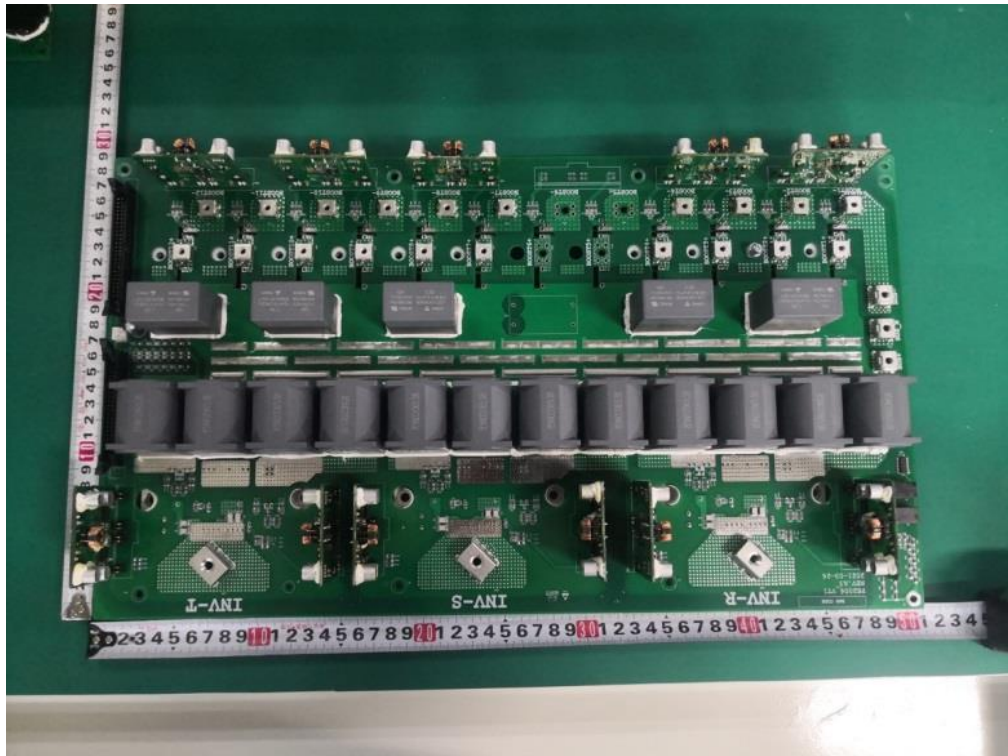

Boost-Inverter board (Components side)

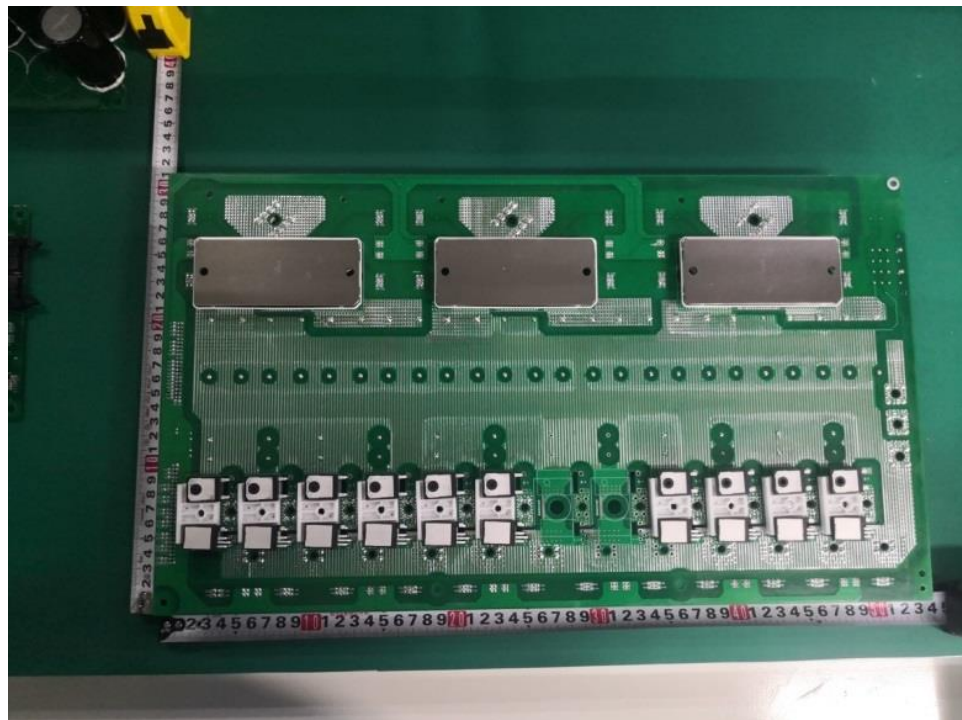

Boost-Inverter board (Soldered side)

(End of Report)